

TMS320TCI6482 DSK

*Technical
Reference*

TMS320TCI6482 DSK

Technical Reference

508555-0201 Rev. C
September 2006

SPECTRUM DIGITAL, INC.
12502 Exchange Drive, Suite 440 Stafford, TX. 77477
Tel: 281.494.4505 Fax: 281.494.5310
sales@spectrumdigital.com www.spectrumdigital.com

IMPORTANT NOTICE

Spectrum Digital, Inc. reserves the right to make changes to its products or to discontinue any product or service without notice. Customers are advised to obtain the latest version of relevant information to verify that the data being relied on is current before placing orders.

Spectrum Digital, Inc. warrants performance of its products and related software to current specifications in accordance with Spectrum Digital's standard warranty. Testing and other quality control techniques are utilized to the extent deemed necessary to support this warranty.

Please be aware that the products described herein are not intended for use in life-support appliances, devices, or systems. Spectrum Digital does not warrant nor is Spectrum Digital liable for the product described herein to be used in other than a development environment.

Spectrum Digital, Inc. assumes no liability for applications assistance, customer product design, software performance, or infringement of patents or services described herein. Nor does Spectrum Digital warrant or represent any license, either express or implied, is granted under any patent right, copyright, or other intellectual property right of Spectrum Digital, Inc. covering or relating to any combination, machine, or process in which such Digital Signal Processing development products or services might be or are used.

WARNING

This equipment is intended for use in a laboratory test environment only. It generates, uses, and can radiate radio frequency energy and has not been tested for compliance with the limits of computing devices pursuant to subpart J of part 15 of FCC rules, which are designed to provide reasonable protection against radio frequency interference. Operation of this equipment in other environments may cause interference with radio communications, in which case the user at his own expense will be required to take whatever measures necessary to correct this interference.

Contents

1	Introduction to the TMS320TCI6482 DSK Module	1-1
	<i>Provides you with a description of the TMS320TCI6482 DSK Module, key features, and block diagram.</i>	
1.1	Key Features	1-2
1.2	Functional Overview	1-3
1.3	Basic Operation	1-4
1.4	Memory Map	1-5
1.5	Configuration Switch Settings	1-6
1.6	Bootmode Configurations	1-7
1.7	Power Supply	1-8
2	Board Components	2-1
	<i>Describes the operation of the major board components on the TMS320TCI6482 DSK.</i>	
2.1	CPLD (programmable Logic)	2-2
2.1.1	CPLD Overview	2-2
2.1.2	CPLD Registers	2-3
2.1.3	USER_REG Register	2-3
2.1.4	DC_REG Register	2-4
2.1.5	Version Register	2-4
2.1.6	MISC Register	2-5
2.1.7	MISC2 Register	2-5
2.2	Codec Interface	2-6
2.3	DDR2 Memory	2-7
2.4	Flash Memory	2-7
2.5	LEDs and DIP Switches	2-7
2.6	Ethernet Interface	2-7
2.7	I ² C ROM	2-8
2.8	Daughter Card Interface	2-8
2.9	DSP and EMIFA Clock Generation	2-8
2.10	JTAG Interface	2-10
3	Physical Specifications	3-1
	<i>Describes the physical layout of the TMS320TCI6482 DSK and its connectors.</i>	
3.1	Board Layout	3-2
3.2	Connector Index	3-3
3.3	Expansion Connectors	3-3
3.3.1	J4, Memory Expansion	3-4
3.3.2	J3, Peripheral Expansion	3-5
3.3.3	J1, HPI Expansion Connector	3-6
3.4	Audio Connectors	3-8
3.4.1	J1301, Microphone Connector	3-8
3.4.2	J1303, Audio Line In Connector	3-8

3.4.3	J1304, Audio Line Out Connector	3-9
3.4.4	J1302, Headphone Connector	3-9
3.5	Power Connectors	3-10
3.5.1	J5, +5V Main Power Connector	3-10
3.5.2	J6, Optional Power Connector	3-10
3.6	Miscellaneous Connectors	3-11
3.6.1	J1201, USB Port	3-11
3.6.2	J8, 14 Pin External JTAG Connector	3-12
3.6.3	J7, 60 Pin Advanced Emulation Connector	3-13
3.6.4	JP3, PLD Programming Connector	3-13
3.6.5	J9, AMCC Connector	3-13
3.6.6	P1102, Ethernet Connector	3-14
3.7	System LEDs	3-14
3.8	SW2, Reset Switch	3-14
A	Schematics	A-1
	<i>Contains the schematics for the TMS320TCI6482 DSK</i>	
B	Mechanical Information	B-1
	<i>Contains the mechanical information about the TMS320TCI6482 DSK</i>	

About This Manual

This document describes the board level operations of the TMS320TCI6482 DSP Starter Kit (DSK) module. The DSK is based on the Texas Instruments TMS320TCI6482 Digital Signal Processor.

The TMS320TCI6482 DSK is a table top card to allow engineers and software developers to evaluate certain characteristics of the TMS320TCI6482 DSP to determine if the processor meets the designers application requirements. Evaluators can create software to execute on board or expand the system in a variety of ways.

Notational Conventions

This document uses the following conventions.

The TMS320TCI6482 DSK will sometimes be referred to as the DSK, C6482 DSK, or TMS320TCI6482 DSK.

Program listings, program examples, and interactive displays are shown in a special italic typeface. Here is a sample program listing.

```
equations  
!rd = !strobe&rw;
```

Information About Cautions

This book may contain cautions.

This is an example of a caution statement.

A caution statement describes a situation that could potentially damage your software, or hardware, or other equipment. The information in a caution is provided for your protection. Please read each caution carefully.

Related Documents

Texas Instruments TMS320C64xx DSP CPU Reference Guide
Texas Instruments TMS320C64xx DSP Peripherals Reference Guide

Table 1: Manual History

Revision	History
A	Initial Release
B	Changed CLKIN to 50 Mhz. Fixed swizzle on daughter card interrupts
C	Corrected connector documentation Replaced sheets 4,5 of schematic

Chapter 1

Introduction to the TMS320TCI6482 DSK

Chapter One provides a description of the TMS320TCI6482 DSK along with the key features and a block diagram of the circuit board.

Topic	Page
1.1 Key Features	1-2
1.2 Functional Overview	1-3
1.3 Basic Operation	1-4
1.4 Memory Map	1-5
1.5 Configuration Switch Settings	1-6
1.6 Bootmode Configurations	1-7
1.7 Power Supply	1-8

1.1 Key Features

The TCI6482 DSK is a high performance standalone development platform that enables users to evaluate and develop applications for the TI C64xx DSP family. The DSK also serves as a hardware reference design for the TMS320TCI6482 DSP. Schematics, logic equations and application notes are available to ease hardware development and reduce time to market.

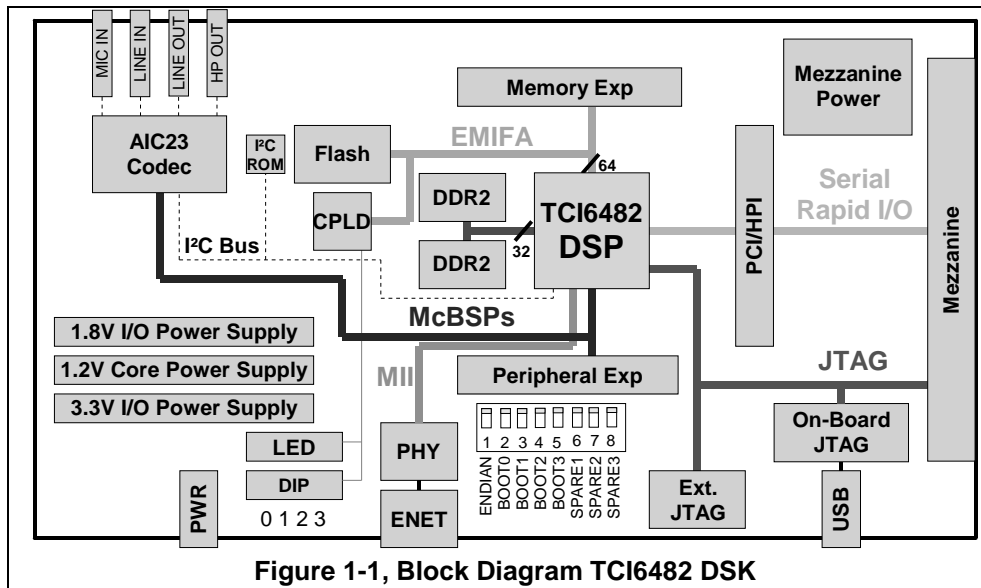

Figure 1-1, Block Diagram TCI6482 DSK

The DSK comes with a full compliment of on-board devices that suit a wide variety of application environments. Key features include:

- A Texas Instruments TMS320TCI6482 DSP operating at 1 Gigahertz.
- An AIC23 stereo codec
- 128 Mbytes of DDR2 memory
- 4M bytes of non-volatile Flash memory
- 10/100 MBPs ethernet interface
- I²C Serial ROM
- 4 user accessible LEDs and DIP switches
- Software board configuration through registers implemented in CPLD
- Configured boot options and clock input selection
- Standard expansion connectors for daughter card use

- JTAG emulation through on-board JTAG emulator with USB host interface or external emulator
- Single voltage power supply (+5V)

1.2 Functional Overview of the TMS320TCI6482 DSK

The DSP on the TCI6482 DSK interfaces to on-board peripherals through the 64-bit wide EMIFA configured for 32 bit accesses. The CPLD and daughter card expansion connectors are connected to EMIFA. The DDR2 memory is on its own dedicated EMIF.

An on-board AIC23 codec allows the DSP to transmit and receive analog signals. I²C is used for the codec control interface and McBSP1 is used for data. Analog I/O is done through four 3.5mm audio jacks that correspond to microphone input, line input, line output and headphone output. The codec can select the microphone or the line input as the active input. The analog output is driven to both the line out (fixed gain) and headphone (adjustable gain) connectors. McBSP0 and McBSP1 can be re-routed to the expansion connectors in software.

A programmable logic device called a CPLD is used to implement glue logic that ties the board components together. The CPLD also has a register based user interface that lets the user configure the board by reading and writing to the CPLD registers.

A Flash memory is mapped into CE3 space. The Flash contains power on self test as shipped, or can be programmed for user programs.

The DSK has a 10/100 mbit Phy which is connected to the DSP's on board EMAC.

The DSK includes 4 LEDs and 4 position DIP switch as a simple way to provide the user with interactive feedback. Both are accessed by reading and writing to the CPLD registers.

An included 5V external power supply is used to power the board. On-board switching voltage regulators provide the 1.2V DSP core voltage, 1.8V for DDR, and 3.3V I/O supplies. The board is held in reset until these supplies are within operating specifications.

Code Composer communicates with the DSK through an embedded JTAG emulator with a USB host interface. The DSK can also be used with an external emulator through the external 60 pin and 14 pin JTAG connectors.

1.3 Basic Operation

The DSK is designed to work with TI's Code Composer Studio development environment and ships with a version specifically tailored to work with the board. Code Composer communicates with the board through the on-board JTAG emulator. To start, follow the instructions in the Quick Start Guide to install Code Composer. This process will install all of the necessary development tools, documentation and drivers.

After the install is complete, follow these steps to run Code Composer. The DSK must be fully connected to launch the DSK version of Code Composer.

- 1) Connect the included power supply to the DSK.
- 2) Connect the DSK to your PC with a standard USB cable (also included).
- 3) Launch Code Composer from its icon on your desktop.

Detailed information about the DSK including a tutorial, examples and reference material is available in the DSK's help file.

1.4 Memory Map

The C64xx family of DSPs has a large byte addressable address space. Program code and data can be placed anywhere in the unified address space. Addresses are always 32-bits wide.

The memory map shows the address space of a generic 6482 processor on the left with specific details of how each region is used on the right. By default, the internal memory sits at the beginning of the address space. Portions of memory can be remapped in software as L2 cache rather than fixed RAM.

EMIFA (External Memory Interface A) has 4 separate addressable regions called chip enable spaces (CE2-CE5). The DDR2 occupies CE0 of DDR2 Memory bus. The CPLD and Flash are mapped to CE2 and CE3 of EMIFA respectively. Daughter cards use CE4 and CE5 of EMIFA.

Address	Generic 6482 Address Space	6482 DSK
0x00000000	Internal Memory	Internal Memory
0x00100000	Reserved Space or Peripheral Regs	Reserved or Peripheral
0xA0000000	EMIFA CE2	CPLD
0xB0000000	EMIFA CE3	Flash
0xC0000000	EMIFA CE4	Daughter Card
0xD0000000	EMIFA CE5	
0xE0000000	DDR2 CE0	DDR2 Memory

Figure 1-2, Memory Map, TCI6482 DSK

1.5 Configuration Switch Settings

The DSK has 8 configuration switches that allows users to control the operational state of the DSP when it is released from reset. The configuration switch block is labeled SW3 on the DSK board, next to the reset switch.

Configuration switch 1 controls the endianness of the DSP. The factory default is little endian. The settings of switch 1 are shown in the table below.

Table 1: Endian Configuration Switch Settings

SW3-1	Configuration Description
Off	Little endian *
On	Big endian

* Default

Switches 2-5 configure the boot mode that will be used when the DSP starts executing. These boot modes are shown in the table below. The default boot mode is EMIFA 8 bit ROM Boot.

Table 2: Boot Load Configuration Switch Settings

SW3-5 AE19	SW3-4 * AE18	SW3-3 AE17	SW3-2 AE16	Configuration Description
Off	Off	Off	Off	No Boot
Off	Off	Off	On	Host Boot HPI
Off	Off	On	Off	Reserved
Off	Off	On	On	Reserved
Off	On	Off	Off	EMIFA 8 bit ROM Boot *
Off	On	Off	On	I ² C Boot Master
Off	On	On	Off	I ² C slave
Off	On	On	On	Host Boot PCI
On	x	x	x	Serial Rapid I/O Boot see DSP data sheet for more details

** Default

On revision "C" and newer boards the switch positions 6-8 are spare switches. The CLKIN frequency is now set to a fixed 50 Mhz. oscillator.

1.6 Bootmode Configurations

The TCI6482 uses the address lines to configure the device configuration at RESET. Although many of these configurations can be changed in software via internal DSP configuration registers, the defaults for the DSK are shown in the table below.

Table 3: Bootmode Configurations

Config Pin Name	Function	Controlled By
AE19	Boot Mode 3	SW3-5
AE18	Boot Mode 2	SW3-4
AE17	Boot Mode 1	SW3-3
AE16	Boot Mode 0	SW3-2
AE15	AECLKIN Selected	Resistor Strap
AE14	HPI 32 bit Mode Selected	Resistor Strap
AE13	Endian Mode	SW3-1
AE12	Ethernet MAC Enabled	Resistor Strap
AE11	Reserved	Resistor Strap
AE10	EMAC MDIO/MII Mode	Resistor Strap
AE9	EMAC MDIO/MII Mode	Resistor Strap
AE8	PCI I ² C ROM Enable	Resistor Strap
AE7	Reserved	Resistor Strap
AE6	PCI 33 Mhz.	Resistor Strap
AE5	McBSP1 Enabled	Resistor Strap
AE4	SYSCLK4 Output	Resistor Strap
AE3	Reserved	Resistor Strap
AE2	CFGGP2	Resistor Strap
AE1	CFGGP1	Resistor Strap
AE0	CFGGP0	Resistor Strap
ABA1	EMIFA Enabled	Resistor Strap
ABA0	DDR Enabled	Resistor Strap

1.7 Power Supply

The DSK operates from a single +5V external power supply connected to the main power input (J5). Internally, the +5V input is converted into +1.5, +1.8V and +3.3V using multiple voltage regulators. The +1.2V supply is used for the DSP core while the +3.3V supply is used for the DSP's I/O buffers and all other chips on the board. The +1.8 volt supply is used to support DDR2 memories. The power connector is a 2.5mm barrel-type plug.

The DSK provides +3.3V, up to 1A for the daughter card. The +3.3V supply is derived from the +5V power source via the main +3.3 volt regulator. It is also possible to provide the daughter card with +12V and -12V when the external power connector (J6) is used.

Chapter 2

Board Components

This chapter describes the operation of the major board components on the TMS320TCI6482 DSK.

Topic	Page
2.1 CPLD (Programmable Logic)	2-2
2.1.1 CPLD Overview	2-2
2.1.2 CPLD Registers	2-3
2.1.3 USER_REG Register	2-3
2.1.4 DC_REG Register	2-4
2.1.5 Version Register	2-4
2.1.6 MISC Register	2-5
2.1.7 MISC2 Register	2-5
2.2 AIC23 Codec	2-6
2.3 DDR2 Memory	2-7
2.4 Flash Memory	2-7
2.5 LEDs and DIP Switches	2-7
2.6 Ethernet Interface	2-7
2.7 I ² C ROM	2-8
2.8 Daughter Card Interface	2-8
2.9 DSP and EMIFA Clock Generation	2-8
2.10 JTAG Interfaces	2-10

2.1 CPLD (Programmable Logic)

The TCI6482 DSK uses an Altera EPM3128TC100-10 Complex Programmable Logic Device (CPLD) device to implement:

- 5 Memory-mapped control/status registers that allow software control of various board features.
- Address decode and memory access logic.
- Control of the daughter card interface and signals.
- Assorted "glue" logic that ties the board components together.

2.1.1 CPLD Overview

The CPLD logic is used to implement functionality specific to the DSK. Your own hardware designs will likely implement a completely different set of functions or take advantage of the DSPs high level of integration for system design and avoid the use of external logic completely.

The CPLD implements simple random logic functions that eliminate the need for additional discrete devices. In particular, the CPLD aggregates the various reset signals coming from the reset button and power supervisors and generates a global reset.

The EPM3128TC100-10 is a 3.3V (5V tolerant), 100-pin QFP device that provides 128 macrocells, 80 I/O pins, and a 10 ns pin-to-pin delay. The device is EEPROM-based and is in-system programmable via a dedicated JTAG interface (a 10-pin header on the DSK). The CPLD source files are written in the industry standard VHDL (Hardware Design Language) and included with the DSK.

2.1.2 CPLD Registers

The 5 CPLD memory-mapped registers allows users to control CPLD functions in software. On the TCI6482 DSK the registers are primarily used to access the LEDs and DIP switches and control the daughter card interface. The registers are mapped into CE2 data space at address 0xA0000000. They appear as 8-bit registers with a simple asynchronous memory interface. The following table gives a high level overview of the CPLD registers and their bit fields:

The table below shows the bit definitions for the 5 registers in CPLD.

Table 1: CPLD Register Definitions

Offset	Name	Bit 7	Bit 6	Bit 5	Bit 4	Bit 3	Bit 2	Bit 1	Bit 0
0	USER_REG	USR_SW3 R	USR_SW2 R	USR_SW1 R	USR_SW0 R	USR_LED3 R/W 0(Off)	USR_LED2 R/W 0(Off)	USR_LED1 R/W 0(Off)	USR_LED0 R/W 0(Off)
1	DC_REG	DC_DET R	0	DC_STAT1 R	DC_STAT0 R	DC_RST R 0(No reset)	0	DC_CNTL1 R/W 0(low)	DC_CNTL0 R/W 0(low)
4	VERSION	CPLD_VER[3:0] R				0	BOARD_VERSION[2:0] R		
6	MISC	McBSP2_EN R (MCBSP2 enabled)	Spare3	Spare2	Spare1	Spare0	Resv 0	Resv 0	McBSP1 ON/OFF Board R/W 0 (Onboard)
7	MISC2	DSPA RSTST (Reset Status)	Resv 0	Resv 0	Resv 0	HUR RST EN	Ethernet PHY RST	CPUB Enable	CPUB PRSNT

2.1.3 USER_REG Register

USER_REG is used to read the state of the 4 DIP switches and turn the 4 LEDs on or off to allow the user to interact with the DSK. The DIP switches are read by reading the top 4 bits of the register and the LEDs are set by writing to the low 4 bits.

Table 2: CPLD USER_REG Register

Bit	Name	R/W	Description
7	USER_SW3	R	User DIP Switch 3(1 = Off, 0 = On)
6	USER_SW2	R	User DIP Switch 2(1 = Off, 0 = On)
5	USER_SW1	R	User DIP Switch 1(1 = Off, 0 = On)
4	USER_SW0	R	User DIP Switch 0(1 = Off, 0 = On)
3	USER_LED3	R/W	User-defined LED 3 Control (0 = Off, 1 = On)
2	USER_LED2	R/W	User-defined LED 2 Control (0 = Off, 1 = On)
1	USER_LED1	R/W	User-defined LED 1 Control (0 = Off, 1 = On)
0	USER_LED0	R/W	User-defined LED 0 Control (0 = Off, 1 = On)

2.1.4 DC_REG Register

DC_REG is used to monitor and control the daughter card interface. DC_DET detects the presence of a daughter card. DC_STAT and DC_CNTL provide simple communications with the daughter card through readable status lines and writable control lines.

The daughter card is released from reset when the DSP is released from reset. DC_RST can be used to put the card back in reset.

Table 3: DC_REG Register

Bit	Name	R/W	Description
7	DC_DET	R	Daughter Card Detect (1= Board detected)
6	0	R	Always 0
5	DC_STAT1	R	Daughter Card Status 1 (0=Low, 1 = High)
4	DC_STAT0	R	Daughter Card Status 0 (0=Low, 1 = High)
3	DC_RST	R/W	Daughter Card Reset (0=No Reset, 1 = Reset)
2	0	R	Always zero
1	DC_CNTL1	R/W	Daughter Card Control 1(0 = Low, 1 = High)
0	DC_CNTL0	R/W	Daughter Card Control 0(0 = Low, 1 = High)

2.1.5 VERSION Register

The VERSION register contains two read only fields that indicate the BOARD and CPLD versions. This register will allow your software to differentiate between production releases of the DSK and account for any variances. This register is not expected to change often, if at all.

Table 4: Version Register Bit Definitions

Bit #	Name	R/W	Description
7	CPLD_VER3	R	Most Significant CPLD Version Bit
6	CPLD_VER2	R	CPLD Version Bit
5	CPLD_VER1	R	CPLD Version Bit
4	CPLD_VER0	R	Least Significant CPLD Version Bit
3	0	R	Always 0
2	DSK_VER2	R	Most Significant DSK Board Version Bit
1	DSK_VER1	R	DSK Board Version Bit
0	DSK_VER0	R	Least Significant DSK Board Version Bit

2.1.6 MISC Register

The MISC register is used to provide software control for miscellaneous board functions. On the TCI6482 DSK, the MISC register controls how auxiliary signals are brought out to the daughter-card connectors.

McBSP1 is usually used as the control and data port of the on-board AIC23 codec. The power-on state of this bit (0) represents that configuration. Set MCBSP0SEL to route the McBSP1 to the daughter card connectors rather than the codec.

The scratch bits are unused. They can be set to any value.

Table 5: MISC Register

Bit	Name	R/W	Description
7	Reserved	R	
6	Spare3	R	Spare switch
5	Spare2	R	Spare switch
4	Spare1	R	Spare switch
3	Spare0	R	Spare switch
2	Reserved	R	
1	Reserved	R	
0	MCBSP1SEL	R/W	McBSP1 on/off board (0 = on-board, 1 = off-board)

2.1.7 MISC2 Register

MISC2 register is used for factory test and EVM functions when a TCI64xx AMCC mezzanine card is used.

This register also contains a bit for resetting the on board PHY.

Bits 0 and 1 are used for EVM configurations. Bit 0 is used to detect that a mezzanine card is plugged into the AMCC slot which is not populated on a DSK. Bit 1 enables the AMCC mezzanine card. When driven to a zero the AMCC card is enabled.

Bit 3 provides a mechanism to reset the ethernet PHY. Writing as 1 resets the on board ethernet PHY.

Bits 4 and 7 are used for factory tests, and the remaining bits are reserved for future use.

Table 6: MISC2 Register

Bit	Name	R/W	Description
7	DSPA RSTST	W	DSP A Reset Status (0 = Not in reset, 1 = In Reset), Factory Test
6	Reserved	R	Not Used
5	Reserved	R	Not Used
4	Reserved	R	Not Used
3	Reserved	R	User-defined LED 3 Control (0 = Off, 1 = On)
2	Ethernet PHY RST	R/W	Ethernet PHY reset Enable (0 = Not Reset, 1 = Reset)
1	CPUB Enable	W	CPU B Reset (0 = Not Reset, 1 = Reset)
0	CPUB PRSNT	R	CPU B Present (0 = Not present, 1 = Present)

2.2 AIC23 Codec

The DSK uses a Texas Instruments AIC23 (part #TLV320AIC23) stereo codec for input and output of audio signals. The codec samples analog signals on the microphone or line inputs and converts them into digital data so it can be processed by the DSP. When the DSP is finished with the data it uses the codec to convert the samples back into analog signals on the line and headphone outputs so the user can hear the output.

The codec communicates using two serial channels, one to control the codec's internal configuration registers and one to send and receive digital audio samples. The TCI6482's I²C interface is used as the unidirectional control channel. The control channel is only used when configuring the codec, it is generally idle when audio data is being transmitted,

McBSP1 is used as the bi-directional data channel. All audio data flows through the data channel. Many data formats are supported based on the three variables of sample width, clock signal source and serial data format. The DSK examples generally use a 55-bit sample width with the codec in master mode so it generates the frame sync and bit clocks at the correct sample rate without effort on the DSP side. The preferred serial format is DSP mode which is designed specifically to operate with the McBSP ports on TI DSPs.

The codec has a 12MHz system clock. The 12MHz system clock corresponds to USB sample rate mode, named because many USB systems use a 12MHz clock and can use the same clock for both the codec and USB controller. The internal sample rate generate subdivides the 12MHz clock to generate common frequencies such as 48KHz, 44.1KHz and 8KHz. The sample rate is set by the codec's SAMPLERATE register. The figure below shows the codec interface on the TCI6482 DSK.

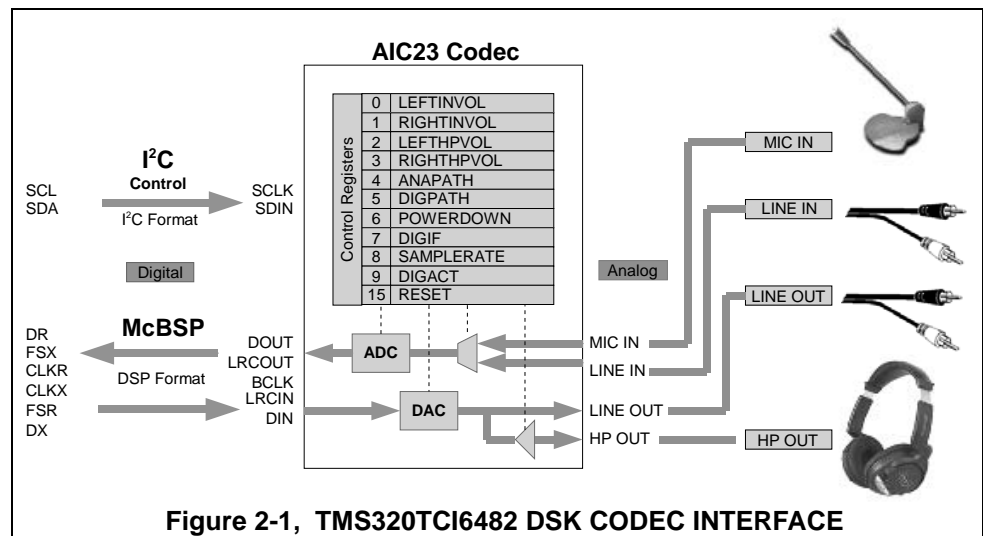

2.3 DDR2 Memory

The DSK uses a pair of industry standard 512 megabit DDR2 in CE0. The two devices are used in parallel to create a 32-bit wide interface. Total available memory is 128 megabytes, and is accessible from addresses 0xE0000 0000 to 0xE800 0000.

The DSK uses a factory setting DDR2 clock at 250 MHz. The integrated DDR2 controller is started by configuring the EMIF in software. Timings can be found in the DDR2 data sheet and the DSK help file.

2.4 Flash Memory

The DSK uses a 4 Mbyte external Flash as a boot option. It is connected to CE3 of EMIFA with an 8-bit interface, and is accessible from addresses 0xB0000 0000 to 0xB01F FFFF. Flash is a type of memory which does not lose its contents when the power is turned off. When read it looks like a simple asynchronous read-only memory (ROM). Flash can be erased in large blocks commonly referred to as sectors or pages. Once a block has been erased each word can be programmed once through a special command sequence. After that the entire block must be erased again to change the contents.

2.5 LEDs and DIP Switches

The DSK includes 4 software accessible LEDs (D7-D10) and DIP switches (SW1) that provide the user a simple form of input/output. Both are accessed through the CPLD USER_REG register.

2.6 Ethernet Interface

An Intel LTX971ACE 10/100 Mbps PHY is connected to the DSP's internal EMAC controller. There are 2 status LEDs which detail the status of the ethernet link.

2.7 I²C ROM

The DSK incorporates a 1 Mbit I²C ROM. The ROM can be used for general storage or configured as a boot device for the DSP.

2.8 Daughter Card Interface

The DSK provides three expansion connectors that can be used to accept plug-in daughter cards. The daughter card allows users to build on their DSK platform to extend its capabilities and provide customer and application specific I/O. The expansion connectors are for memory, peripherals, and the Host Port Interface (HPI)

The memory connector provides access to the DSP's asynchronous EMIF signals to interface with memories and memory mapped devices. It supports byte addressing on 32 bit boundaries. The peripheral connector brings out the DSP's peripheral signals like McBSPs, timers, and clocks. Both connectors provide power and ground to the daughter card.

The HPI is a high speed interface that can be used to allow multiple DSPs to communicate and cooperate on a given task. The HPI connector brings out the HPI specific control signals as well as a PCI multiplexed interface.

Most of the expansion connector signals are buffered so that the daughter card cannot directly influence the operation of the DSK board. The use of TI low voltage, 5V tolerant buffers, and CBT interface devices allows the use of either +5V or +3.3V devices to be used on the daughter card.

Other than the buffering, most daughter card signals are not modified on the board. However, a few daughter card specific control signals like DC_RESET and DC_DET exist and are accessible through the CPLD DC_REG register. The DSK also multiplexes the McBSP1 for on board or external use. This function is controlled through the CPLD MISC register.

2.9 DSP and EMIFA Clock Generation

The TCI6482 DSK uses the internal DSP dividers to select the user PLL frequency, and multiple oscillators. This allows the DSK to support 600, 725, 850, 1000, and 1200 megahertz CPU clocks. However, the default configuration is 1 gigahertz and the software shipped with the DSK assumes the default configuration.

2.10 JTAG Interfaces

The DSK supports embedded emulation controller as its primary debug channel. However it has an option to support 14 pin and 60 pin TI style JTAG connections for external emulators. When either the 14 pin or 60 pin interface is plugged into the DSK the on board embedded emulator is disabled. The 60 pin interface also supports trace functions when used with the appropriate trace emulation platform.

Chapter 3

Physical Description

This chapter describes the physical layout of the TMS320TCI6482 DSK and its connectors.

Topic	Page
3.1 Board Layout	3-2
3.2 Connector Index	3-3
3.3 Expansion Connectors	3-3
3.3.1 J4, Memory Expansion Connector	3-4
3.3.2 J3, Peripheral Expansion Connector	3-5
3.3.3 J1, PCI Expansion Connector	3-6
3.3.4 J1, Used as HPI Expansion Connector	3-6
3.4 Audio Connectors	3-8
3.4.1 J1301, Microphone Connector	3-8
3.4.2 J1303, Audio Line In Connector	3-8
3.4.3 J1304, Audio Line Out Connector	3-9
3.4.4 J1302, Headphone Connector	3-9
3.5 Power Connectors	3-10
3.5.1 J5, +5 Volt Connector	3-10
3.5.2 J6, Optional Power Connector	3-10
3.6 Miscellaneous Connectors	3-11
3.6.1 J1201, USB Connector	3-11
3.6.2 J8, 14 Pin External JTAG Connector	3-12
3.6.3 J7, 60 Pin Advanced Emulation Connector	3-13
3.6.4 JP3, PLD Programming Connector	3-13
3.6.5 J9, AMCC Connector	3-13
3.6.6 P1102, Ethernet Connector	3-14
3.7 System LEDs	3-14
3.8 SW2, Reset Switch	3-14

3.1 Board Layout

The TCI6482 DSK is a 10.0 x 4.5 inch (254 x 115 mm.) multi-layer board which is powered by an external +5 volt only power supply. Figure 3-1 shows the layout of the TCI6482 DSK.

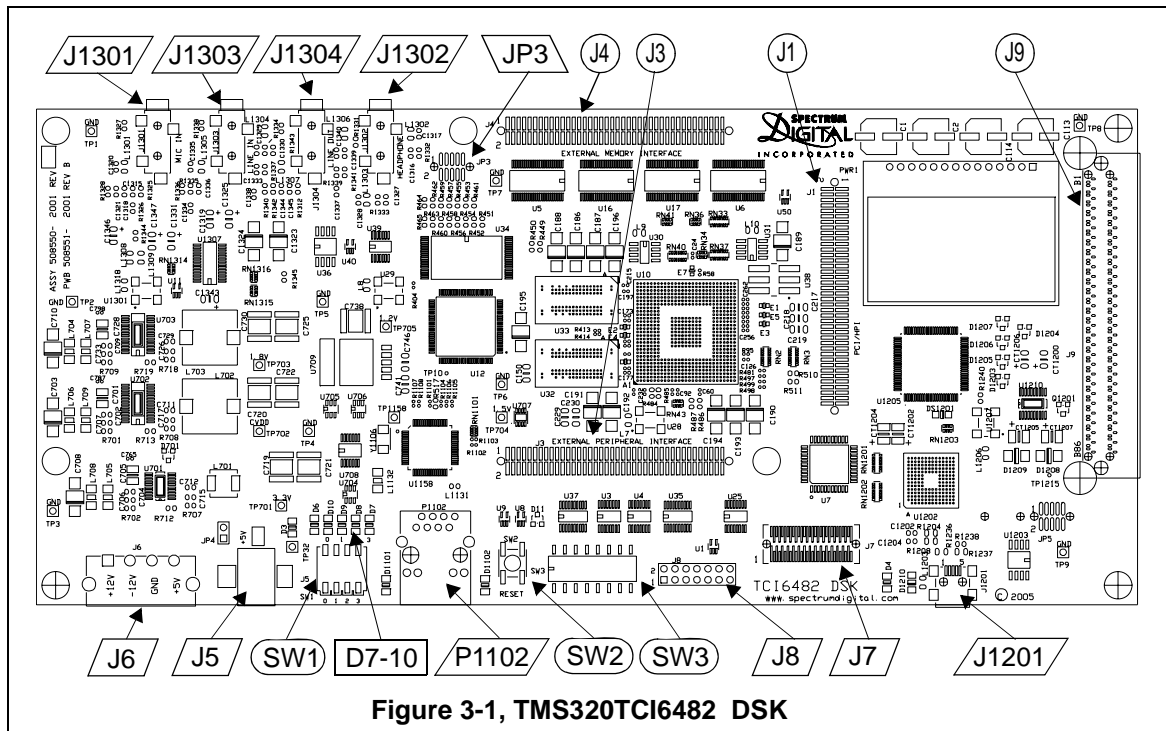

Figure 3-1, TMS320TCI6482 DSK

3.2 Connector Index

The TMS320TCI6482 DSK has many connectors which provide the user access to the various signals on the DSK.

Table 1: TMS320TCI6482 DSK Connectors

Connector	# Pins	Function
J4	80	Memory
J3	80	Peripheral
J1	80	HPI
J1301	3	Microphone
J1303	3	Line In
J1304	3	Line Out
J1302	3	Headphone
J5	2	+5 Volt
J6 *	4	Optional Power Connector
J7	80	Enhanced JTAG Connector
J8	14	External JTAG
J1201	5	USB Port
JP3	4	CPLD Programming
P1102	8	Ethernet
SW3	8	DSP Configuration Switch

Note: "*" Not populated

3.3 Expansion Connectors

The TMS320TCI6482 DSK supports three expansion connectors that follow the Texas Instruments interconnection guidelines. The expansion connector pinouts are described in the following three sections.

The three expansion connectors are all 80 pin 0.050 x 0.050 inches low profile connectors from Samtec or AMP. The Samtec SFM Series (surface mount) connectors are designed for high speed interconnections because they have low propagation delay, capacitance, and cross talk. The connectors present a small foot print on the DSK. Each connector includes multiple ground, +5V, and +3.3V power signals so that the daughter card can obtain power directly from the DSK. The peripheral expansion connector additionally provides both +12V and -12V to the daughter card. The recommended mating connector, whose part number is TFM-140-32-S-D-LC, is a surface mount connector that provides a 0.465" mated height.

Note: I is on an Input pin
 O is on an Output pin
 Z is on a High Impedance pin

3.3.1 J4, Memory Expansion Connector

Table 2: J4, Memory Expansion Connector

Pin	Signal	I/O	Description	Pin	Signal	I/O	Description
1	5V	Vcc	5V voltage supply pin	2	5V	Vcc	5V voltage supply pin
3	AEA19	O	EMIF address pin 21	4	AEA18	O	EMIF address pin 20
5	AEA17	O	EMIF address pin 19	6	AEA16	O	EMIF address pin 18
7	AEA15	O	EMIF address pin 17	8	AEA14	O	EMIF address pin 16
9	AEA13	O	EMIF address pin 15	10	AEA12	O	EMIF address pin 14
11	GND	Vss	System ground	12	GND	Vss	System ground
13	AEA11	O	EMIF address pin 13	14	AEA10	O	EMIF address pin 12
15	AEA9	O	EMIF address pin 11	16	AEA8	O	EMIF address pin 10
17	AEA7	O	EMIF address pin 9	18	AEA6	O	EMIF address pin 8
19	AEA5	O	EMIF address pin 7	20	AEA4	O	EMIF address pin 6
21	5V	Vcc	5V voltage supply pin	22	5V	Vcc	5V voltage supply pin
23	AEA3	O	EMIF address pin 5	24	AEA2	O	EMIF address pin 4
25	AEA1	O	EMIF address pin 3	26	AEA0	O	EMIF address pin 2
27	ABE3#	O	EMIF byte enable 3	28	ABE2#	O	EMIF byte enable 2
29	ABE1#	O	EMIF byte enable 1	30	ABE0#	O	EMIF byte enable 0
31	GND	Vss	System ground	32	GND	Vss	System ground
33	AED31	I/O	EMIF data pin 31	34	AED30	I/O	EMIF data pin 30
35	AED29	I/O	EMIF data pin 29	36	AED28	I/O	EMIF data pin 28
37	AED27	I/O	EMIF data pin 27	38	AED26	I/O	EMIF data pin 26
39	AED25	I/O	EMIF data pin 25	40	AED24	I/O	EMIF data pin 24
41	3.3V	Vcc	3.3V voltage supply pin	42	3.3V	Vcc	3.3V voltage supply pin
43	AED23	I/O	EMIF data pin 23	44	AED22	I/O	EMIF data pin 22
45	AED21	I/O	EMIF data pin 21	46	AED20	I/O	EMIF data pin 20
47	AED19	I/O	EMIF data pin 19	48	AED18	I/O	EMIF data pin 18
49	AED17	I/O	EMIF data pin 17	50	AED16	I/O	EMIF data pin 16
51	GND	Vss	System ground	52	GND	Vss	System ground
53	AED15	I/O	EMIF data pin 15	54	AED14	I/O	EMIF data pin 14
55	AED13	I/O	EMIF data pin 13	56	AED12	I/O	EMIF data pin 12
57	AED11	I/O	EMIF data pin 11	58	AED10	I/O	EMIF data pin 10
59	AED9	I/O	EMIF data pin 9	60	AED8	I/O	EMIF data pin 8
61	GND	Vss	System ground	62	GND	Vss	System ground
63	AED7	I/O	EMIF data pin 7	64	AED6	I/O	EMIF data pin 6
65	AED5	I/O	EMIF data pin 5	66	AED4	I/O	EMIF data pin 4
67	AED3	I/O	EMIF data pin 3	68	AED2	I/O	EMIF data pin 2
69	AED1	I/O	EMIF data pin 1	70	AED0	I/O	EMIF data pin 0
71	GND	Vss	System ground	72	GND	Vss	System ground
73	AARE#	O	EMIF async read enable	74	AAWE#	O	EMIF async write enable
75	AAOE#	O	EMIF async output enable	76	AARDY	I	EMIF asynchronous ready
77	ACE3#	O	Chip enable 3	78	ACE2#	O	Chip enable 2
79	GND	Vss	System ground	80	GND	Vss	System ground

3.3.2 J3, Peripheral Expansion Connector

Table 3: J3, Peripheral Expansion Connector

Pin	Signal	I/O	Description	Pin	Signal	I/O	Description
1	12V	Vcc	12V voltage supply pin	2	-12V	Vcc	-12V voltage supply pin
3	GND	Vss	System ground	4	GND	Vss	System ground
5	5V	Vcc	5V voltage supply pin	6	5V	Vcc	5V voltage supply pin
7	GND	Vss	System ground	8	GND	Vss	System ground
9	5V	Vcc	5V voltage supply pin	10	5V	Vcc	5V voltage supply pin
11	N/C	-	No connect	12	N/C	-	No connect
13	N/C	-	No connect	14	N/C	-	No connect
15	N/C	-	No connect	16	N/C	-	No connect
17	N/C	-	No connect	18	N/C	-	No connect
19	3.3V	Vcc	3.3V voltage supply pin	20	3.3V	Vcc	3.3V voltage supply pin
21	CLKX0	I/O	McBSP0 transmit clock	22	CLKS0	I	McBSP0 clock source
23	FSX0	I/O	McBSP0 transmit frame sync	24	DX0	O	McBSP0 transmit data
25	GND	Vss	System ground	26	GND	Vss	System ground
27	CLKR0	I/O	McBSP0 receive clock	28	N/C	-	No connect
29	FSR0	I/O	McBSP0 receive frame sync	30	DR0	I	McBSP0 receive data
31	GND	Vss	System ground	32	GND	Vss	System ground
33	CLKX2	I/O	McBSP2 transmit clock	34	CLKS2	I	McBSP2 clock source
35	FSX2	I/O	McBSP2 transmit frame sync	36	DX2	O	McBSP2 transmit data
37	GND	Vss	System ground	38	GND	Vss	System ground
39	CLKR2	I/O	McBSP2 receive clock	40	N/C	-	No connect
41	FSR2	I/O	McBSP2 receive frame sync	42	DR2	I	McBSP2 receive data
43	GND	Vss	System ground	44	GND	Vss	System ground
45	TOUT0	O	Timer 0 output	46	TINP0	I	Timer 0 input
47	N/C	-	No connect	48	EXT_INT5	I	External interrupt 5
49	TOUT1	O	Timer 1 output	50	TINP1	I	Timer 1 input
51	GND	Vss	System ground	52	GND	Vss	System ground
53	EXT_INT4	I	External interrupt 4	54	N/C	-	No connect
55	N/C	-	No connect	56	N/C	-	No connect
57	N/C	-	No connect	58	N/C	-	No connect
59	RESET	O	System reset	60	N/C	-	No connect
61	GND	Vss	System ground	62	GND	Vss	System ground
63	CNTL1	O	Daughtercard control 1	64	CNTL0	O	Daughtercard control
65	STAT1	I	Daughtercard status 1	66	STAT0	I	Daughtercard status
67	EXT_INT6	I	External interrupt 6	68	EXT_INT7	I	External interrupt 7
69	ACE3#	O	Chip enable 3	70	N/C	-	No connect
71	N/C	-	No connect	72	N/C	-	No connect
73	N/C	-	No connect	74	N/C	-	No connect
75	DC_DET#	Vss	System ground	76	GND	Vss	System ground
77	GND	Vss	System ground	78	ECL KOUT	O	EMIF Clock
79	GND	Vss	System ground	80	GND	Vss	System ground

3.3.3 J1, PCI Expansion Connector

Table 4: J1, PCI Expansion Connector

Pin	Signal	I/O	Description	Pin	Signal	I/O	Description
1	PCI_EN	I	PCI enable	2	Resv	N/C	Resv
3	GND	Vss	System ground	4	HPI_RS#	I	HPI reset
5	Resv	N/C	Resv	6	Resv	N/C	Resv
7	GND	Vss	System ground	8	GND	Vss	System ground
9	AD1	I/O	PCI address/data 1	10	GP[2]	I/O	General purpose I/O
11	AD3	I/O	PCI address/data 3	12	AD0	I/O	PCI address/data 0
13	AD5	I/O	PCI address/data 5	14	AD2	I/O	PCI address/data 2
15	AD7	I/O	PCI address/data 7	16	AD4	I/O	PCI address/data 4
17	GND		System ground	18	AD6	I/O	PCI address/data 6
19	AD8	I/O	PCI address/data 8	20	GND	Vss	System ground
21	AD10	I/O	PCI address/data 10	22	AD9	I/O	PCI address/data 9
23	AD12	I/O	PCI address/data 12	24	AD11	I/O	PCI address/data 11
25	AD14	I/O	PCI address/data 14	26	AD13	I/O	PCI address/data 13
27	GND	Vss	System ground	28	AD15	I/O	PCI address/data 15
29	PCBE1#	I/O	PCI command/byte ena 1	30	GND	Vss	System ground
31	GND	Vss	System ground	32	PPAR	I/O	PCI parity
33	PSERR#	I/O	PCI system error	34	GND	Vss	System ground
35	GND	Vss	System ground	36	PSTOP#	I/O	PCI stop
37	PPERR#	I/O	PCI parity error	38	GND	Vss	System ground
39	GND	Vss	System ground	40	Resv		None
41	PDEVSEL#	I/O	PCI device select	42	GND	Vss	System ground
43	GND	Vss	System ground	44	PFRAME#	I/O	PCI Frame
45	PIRDY#	I/O	PCI initiator ready	46	GND	Vss	System ground
47	GND	Vss	System ground	48	AD16	I/O	PCI address/data 16
49	PCBE2#	I/O	PCI command/byte ena 2	50	AD18	I/O	PCI address/data 18
51	AD17	I/O	PCI address/data 17	52	AD20	I/O	PCI address/data 20
53	AD19	I/O	PCI address/data 19	54	AD22	I/O	PCI address/data 22
55	AD21	I/O	PCI address/data 21	56	GND	Vss	System ground
57	AD23	I/O	PCI address/data 23	58	Resv		None
59	Resv		None	60	AD24	I/O	PCI address/data 24
61	GND	Vss	System ground	62	AD26	I/O	PCI address/data 26
63	AD25	I/O	PCI address/data 25	64	AD28	I/O	PCI address/data 28
65	AD27	I/O	PCI address/data 27	66	AD30	I/O	PCI address/data 30
67	AD29	I/O	PCI address/data 29	68	GP[12]	I/O	General purpose I/O
69	AD31	I/O	PCI address/data 31	70	GND	Vss	System ground
71	GND	Vss	System ground	72	GP[13]	I/O	General purpose I/O
73	GP[15]	I/O	General purpose I/O	74	GND	Vss	System ground
75	GND	Vss	System ground	76	GP[14]	I/O	General purpose I/O
77	PCLK	I	PCI Clock	78	GND	Vss	System ground
79	GND	Vss	System ground	80	N/C	-	No connect

3.3.4 J1, Used As HPI Expansion Connector

Table 5: J1, Used as HPI Expansion Connector

Pin	Signal	I/O	Description	Pin	Signal	I/O	Description
1	PCI_EN	I	PCI enable	2	Resv	N/C	Resv
3	GND	Vss	System ground	4	HPI_RS#	I	HPI reset
5	Resv	N/C	Resv	6	Resv	N/C	Resv
7	GND	Vss	System ground	8	GND	Vss	System ground
9	HD1	I/O	Host data 1	10	PCBE0#	I/O	PCI command/byte ena 0
11	HD3	I/O	Host data 3	12	HD0	I/O	Host data 0
13	HD5	I/O	Host data 5	14	HD2	I/O	Host data 2
15	HD7	I/O	Host data 7	16	HD4	I/O	Host data 4
17	GND		System ground	18	HD6	I/O	Host data 6
19	HD8	I/O	Host data 8	20	GND	Vss	System ground
21	HD10	I/O	Host data 10	22	HD9	I/O	Host data 9
23	HD12	I/O	Host data 12	24	HD11	I/O	Host data 11
25	HD14	I/O	Host data 14	26	HD13	I/O	Host data 13
27	GND	Vss	System ground	28	HD15	I/O	Host data 15
29	HDS2#	I/O	Host data strobe 2	30	GND	Vss	System ground
31	GND	Vss	System ground	32	HAS#	I/O	Host address strobe
33	HDS1#	I/O	Host data strobe 1	34	GND	Vss	System ground
35	GND	Vss	System ground	36	HCNTL0	I/O	Host Control 0
37	HCS#	I/O	Host chip select	38	GND	Vss	System ground
39	GND	Vss	System ground	40	PTRDY#	I/O	PCI target ready
41	HCNTL1	I/O	Host Control 1	42	GND	Vss	System ground
43	GND	Vss	System ground	44	HINT#	I/O	Host Interrupt
45	HRDY#	I/O	Host ready	46	GND	Vss	System ground
47	GND	Vss	System ground	48	HD16	I/O	Host data 16
49	HR/W#	I/O	Host Read/Write	50	HD18	I/O	Host data 18
51	HD17	I/O	Host data 17	52	HD20	I/O	Host data 20
53	HD19	I/O	Host data 19	54	HD22	I/O	Host data 22
55	HD21	I/O	Host data 21	56	GND	Vss	System ground
57	HD23	I/O	Host data 23	58	Resv		Resv
59	Resv		Resv	60	HD24	I/O	Host data 24
61	GND	Vss	System ground	62	HD26	I/O	Host data 26
63	HD25	I/O	Host data 25	64	HD28	I/O	Host data 28
65	HD27	I/O	Host data 27	66	HD30	I/O	Host data 30
67	HD29	I/O	Host data 29	68	PGNT#	I	PCI bus grant
69	HD31	I/O	Host data 31	70	GND	Vss	System ground
71	GND	Vss	System ground	72	Resv		Resv
73	Resv		Resv	74	GND	Vss	System ground
75	GND	Vss	System ground	76	Resv		Resv
77	Resv		Resv	78	GND	Vss	System ground
79	GND	Vss	System ground	80	N/C	-	No connect

3.4 Audio Connectors

The TCI6482 DSK has 4 audio connectors. They are described in the following sections.

3.4.1 J1301, Microphone Connector

The input is a 3.5 mm. stereo jack. Both inputs are connected to the microphone so it is monaural. The signals on the plug are shown in the figure below.

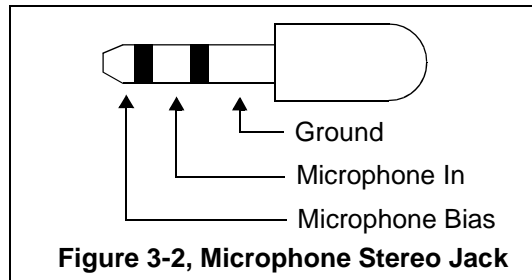

3.4.2 J1303, Audio Line In Connector

The audio line in is a stereo input. The input connector is a 3.5 mm stereo jack. The signals on the mating plug are shown in the figure below.

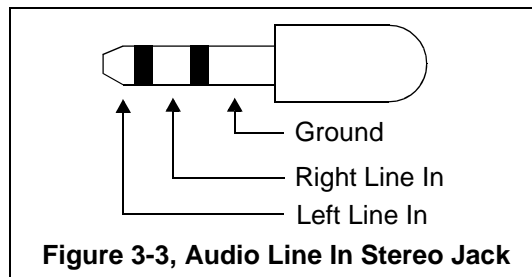

3.4.3 J1304, Audio Line Out Connector

The audio line out is a stereo output. The output connector is a 3.5 mm stereo jack. The signals on the mating plug are shown in the figure below.

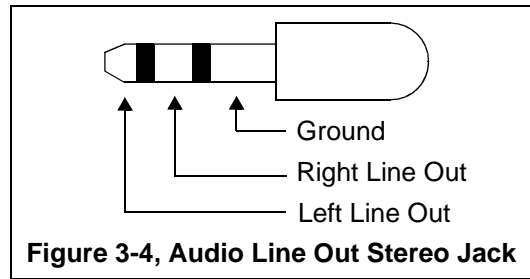

3.4.4 J1302, Headphone Connector

Connector J1302 is a headphone/speaker jack. It can drive standard headphones or a high impedance speaker directly. The standard 3.5 mm jack is shown in the figure below.

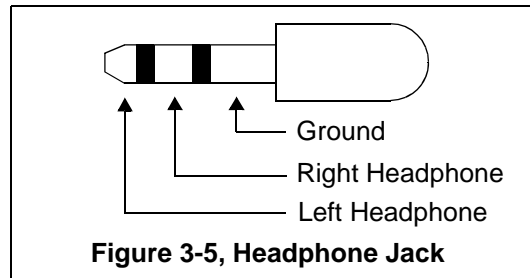

3.5 Power Connectors

The TCI6482 DSK has 2 power connectors. They are described in the following sections.

3.5.1 J5, +5 Volt Connector

Power (+5 volts) is brought onto the TMS320TCI6482 DSK via connector J5. The connector has an outside diameter of 5.5 mm. and an inside diameter of 2.5 mm. The A diagram of J5 is shown below.

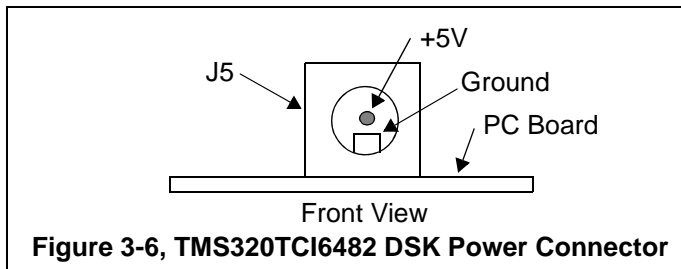

3.5.2 J6, Optional Power Connector

Connector J6 is an optional power connector. It will operate with the standard personal computer power supply. To populate this connector use a Molex #15109-0410 or Tyco #174552-1. The table below shows the voltages on the respective pins.

Table 6: J6, Optional Power Connector

Pin #	Voltage Level
1	+12 Volts
2	-12 Volts
3	Ground
4	+5 Volts

WARNING !
Do not plug into J5 and J6 at the same time.

3.6 Miscellaneous Connectors

The TCI6482 DSK has 6 additional connectors to aid the user in developing with this product. They are described in the following sections.

3.6.1 J1201, USB Connector

Connector J1201 provides a Universal Serial Bus (USB) Interface to the embedded JTAG emulation logic on the DSK. This allows for code development and debug without the use of an external emulator. The signals on this connector are shown in the below.

Table 7: J1201, USB Connector

Pin #	USB Signal Name
1	USBVdd
2	D+
3	D-
4	USB Vss
5	Shield
6	Shield

3.6.2 J8, 14 Pin External JTAG Connector

The TMS320TCI6482 DSK is supplied with a 14 pin header interface, J8. This is the standard interface used by JTAG emulators to interface to Texas Instruments DSPs. The pinout for the connector is shown figure 3-6 below.

TMS	1	2	TRST-	Header Dimensions Pin-to-Pin spacing, 0.100 in. (X,Y) Pin width, 0.025-in. square post Pin length, 0.235-in. nominal
TDI	3	4	GND	
PD (+3.3V)	5	6	no pin (key)	
TDO	7	8	GND	
TCK-RET	9	10	GND	
TCK	11	12	GND	
EMU0	13	14	EMU1	

Figure 3-7, JTAG INTERFACE

The signal names for each pin are shown in the table below.

Table 8: J8, JTAG Interface

Pin #	Signal Name
1	TMS
2	TRST-
3	TDI
4	GND
5	PD
6	no pin
7	TDO
8	GND
9	TCK-RET
10	GND
11	TCK
12	GND
13	EMU0
14	EMU1

3.6.3 J7, 60 Pin Advanced Emulation Connector

The 60 pin emulation connector is mounted on the side of the board near the 14 pin JTAG connector. This connector is for advanced emulation capability. The signals on this connector are 4 columns by 15 rows as shown in the table below

Table 9: J7, 60 Pin Emulation Connector

Row #	Column A Signal Name	Column B Signal Name	Column C Signal Name	Column D Signal Name
1	Ground	IDO	ID2	Ground
2	Ground	TMS	EMU18	Ground
3	Ground	EMU17	TRSTn	Ground
4	Ground	TDI	EMU16	Ground
5	Ground	EMU14	EMU15	Ground
6	Ground	EMU12	EMU13	Ground
7	Ground	TDO	EMU11	Ground
8	TYPE0	TVD	TCLKRTN	TYPE1
9	Ground	EMU9	EMU10	Ground
10	Ground	EMU7	EMU8	Ground
11	Ground	EMU5	EMU6	Ground
12	Ground	TCLK	EMU4	Ground
13	Ground	EMU2	EMU3	Ground
14	Ground	EMU0	EMU1	Ground
15	Ground	ID1	ID3	Ground

3.6.4 JP3, PLD Programming Connector

This connector interfaces to the Altera CPLD, U12. It is used in the in the factory for the programming of the CPLD. This connector is not intended to be used outside the factory.

3.6.5 J9, AMCC Connector

This connector provides a high speed Serial Rapid I/O to other platforms. This connector has 170 pins. This connector is not populated on DSK platforms.

3.6.6 P1102, Ethernet Connector

Connector P1102 is a standard RJ-45 ethernet connector. The connector pin out is shown below.

Table 10: P1102, Ethernet Connector

Pin #	Signal Name
1	TXD+
2	TXD-
3	RXD+
4	TXD-CT
5	Not User
6	RXD-
7	NC
8	Ground

3.7 System LEDs

The TMS320TCI6482 DSK has four system light emitting diodes (LEDs). These LEDs indicate various conditions on the DSK. These function of each LED is shown in the table below.

Table 11: System LEDs

Reference Designator	Color	Function	On Signal State
D4	Green	USB Emulation in use. When External JTAG Emulator is used this LED is off.	1
D3	Green	+5 Volt present	1
D6	Orange	RESET Active	1
DS201	Green	USB Active, Blinks during USB data transfer	1
DS1101	Yellow	Ethernet Status	0
DS1102	Green	Ethernet Status	0

3.8 SW2, Reset Switch

There are three resets on the TMS320TCI6482 DSK. The first reset is the power on reset. This circuit waits until power is within the specified range before releasing the power on reset pin to the TMS320TCI6482.

External sources which control the reset are push button SW2, and the on board embedded USB JTAG emulator.

Appendix A

Schematics

This appendix contains the schematics for the TMS320TCI6482 DSK.

SCHMATIC CONTENTS:

- 1 COVER SHEET
- 2 USER OPTIONS
- 3 Clock Inputs
- 4 6482 DDR2 Interface
- 5 DDR2 Memories
- 6 6482 EMIF A
- 7 BOOT Options
- 8 CPLD
- 9 FLASH MEMORY
- 10 6482 MII INTERFACE
- 11 MCBSP INTERFACE
- 12 6482 HOST PORT INTERFACE
- 13 6482 SRIO INTERFACE
- 14 DSK DAUGHTERCARD BUFFERS
- 15 DSK DAUGHTERCARD INTERFACE
- 16 6482 POWER PINS I
- 17 6482 POWER PINS II
- 18 6482 EMULATION
- 19 6482 EMULATION INTERFACE
- 20 EMULATION INTERFACE
- 21 HIERARCHICAL BLOCKS
- 22 6482 RGMII INTERFACE
- 23 6482 DECOUPLING CAPS I
- 24 6482 DECOUPLING CAPS II
- 25 POWER INPUT
- 26 AIC23 CODEC
- 27 ETHERNET PHY
- 28 DSK POWER SUPPLIES I
- 29 DSK POWER SUPPLIES II

30-34 Embedded Emulation are not Included

REVISION STATUS OF SHEETS															
REV	DATE	BY	CHK	APP	USED FOR	1	2	3	4	5	6	7	8	9	10
A		R.R.P.			REPLICATION										
21	AUG 01 2005	R.R.P.													
22	AUG 01 2005	J.T.C.													
11	AUG 01 2005	R.R.P.													
12	AUG 01 2005	C.M.D.													
13	AUG 01 2005	C.M.D.													
14	AUG 01 2005	C.M.D.													
15	AUG 01 2005	C.M.D.													
16	AUG 01 2005	C.M.D.													
17	AUG 01 2005	C.M.D.													
18	AUG 01 2005	C.M.D.													
19	AUG 01 2005	C.M.D.													
20	AUG 01 2005	C.M.D.													

SPECTRUM DIGITAL INCORPORATED			
Title:	TMS320TC16482 DSK		
Page Contents:	Title Block		
Sheet:	DWG NO	50852-2001	Revision: C
Date:	Monday, June 28, 2005		Sheet 1 of 34

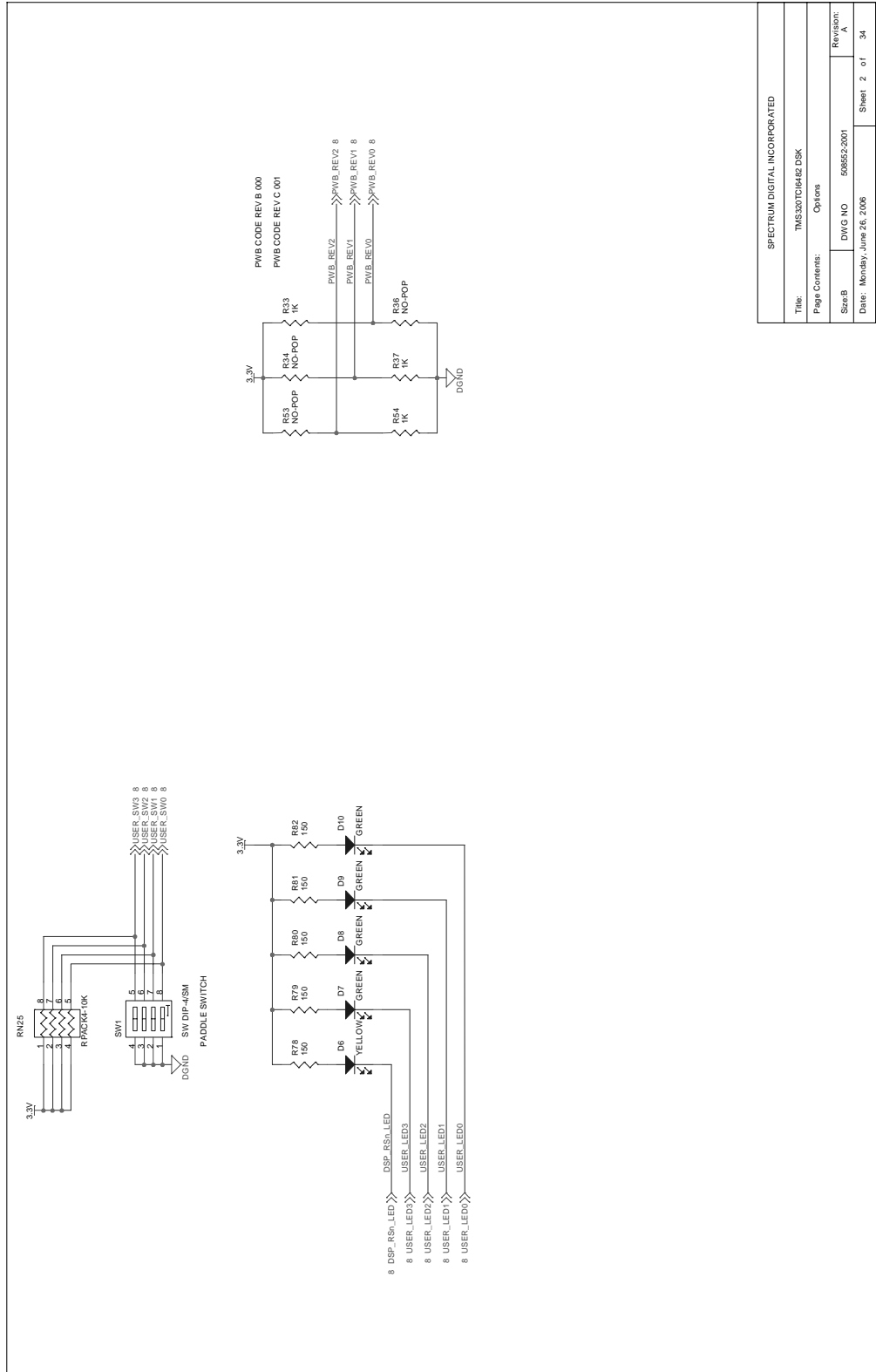

SPECTRUM DIGITAL INCORPORATED			
Title:	TMS320C16432 DSK		
Page Contents:	Options		
Size: B	DWG NO	50852.2001	Revision: A
Date:	Monday, June 28, 2005		Sheet: 2 of 34

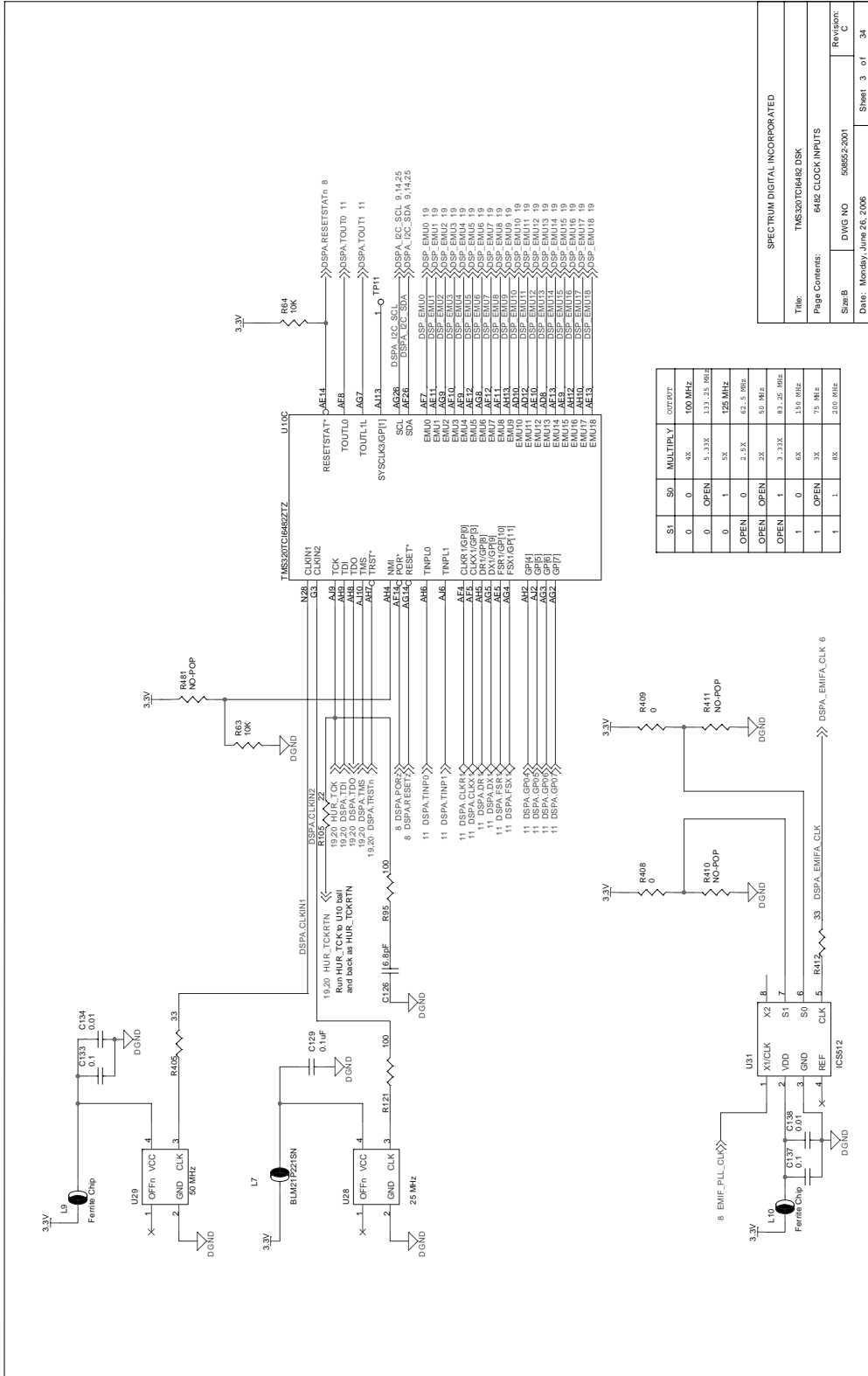

A-4

TMS320TC16482 DSK Module Technical Reference

SPECTRUM DIGITAL INCORPORATED			
Title:	TMS320TC16482 DSK		
Page Comment:	6482 CLOCK INPUTS		
Sheet:	D/WG NO	508652-001	Revision: C
Date:	Monday, June 26, 2006		
			Sheet 3 of 34

SI	SD	MULTIPLY	OUTPUT
0	0	4X	100 MHz
0	OPEN	5.33X	133.25 MHz
0	1	5X	125 MHz
OPEN	0	2.5X	62.5 MHz
OPEN	OPEN	2X	50 MHz
OPEN	1	3.33X	83.25 MHz
1	0	6X	150 MHz
1	OPEN	3X	75 MHz
1	1	1X	100 MHz

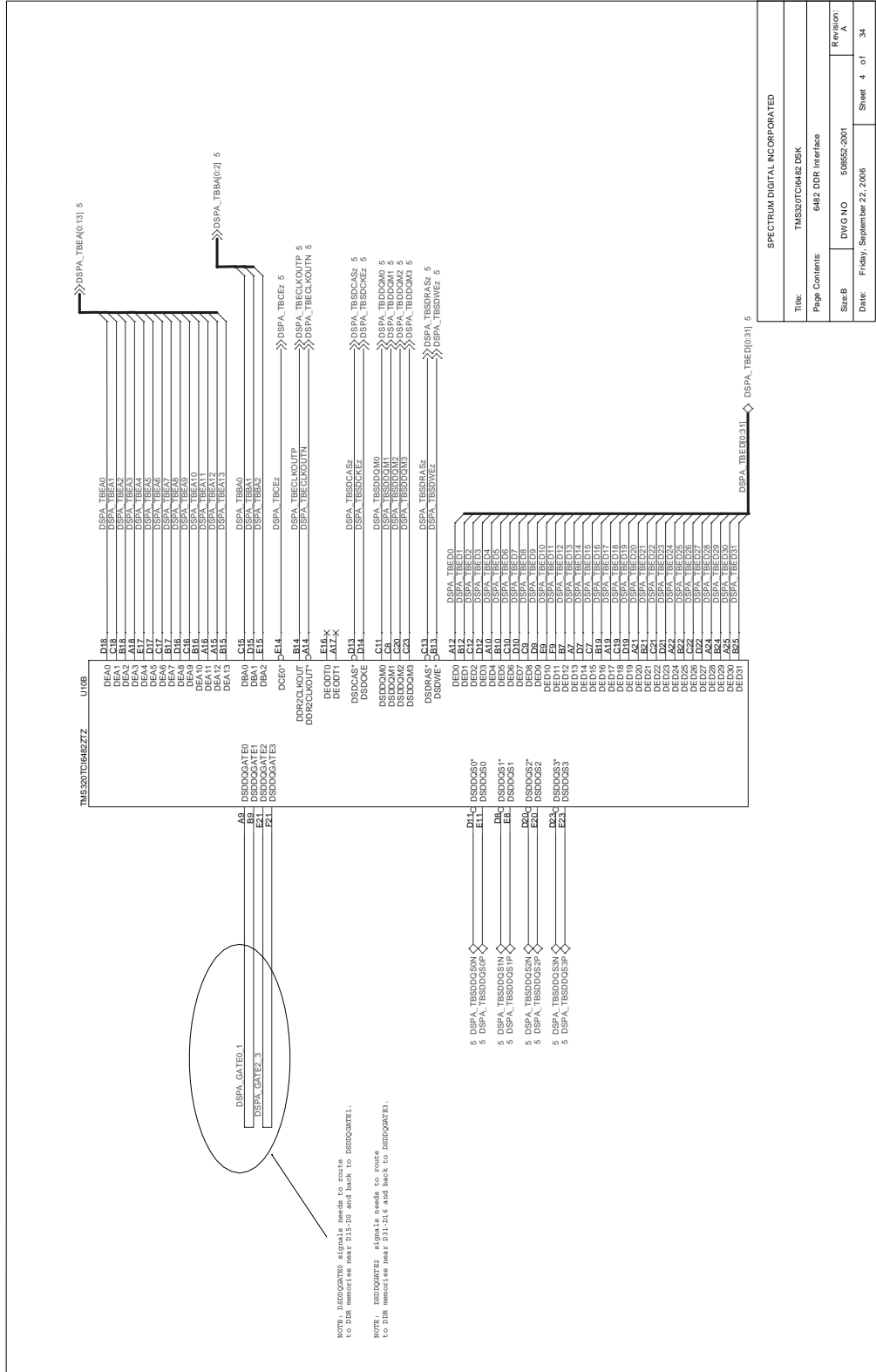

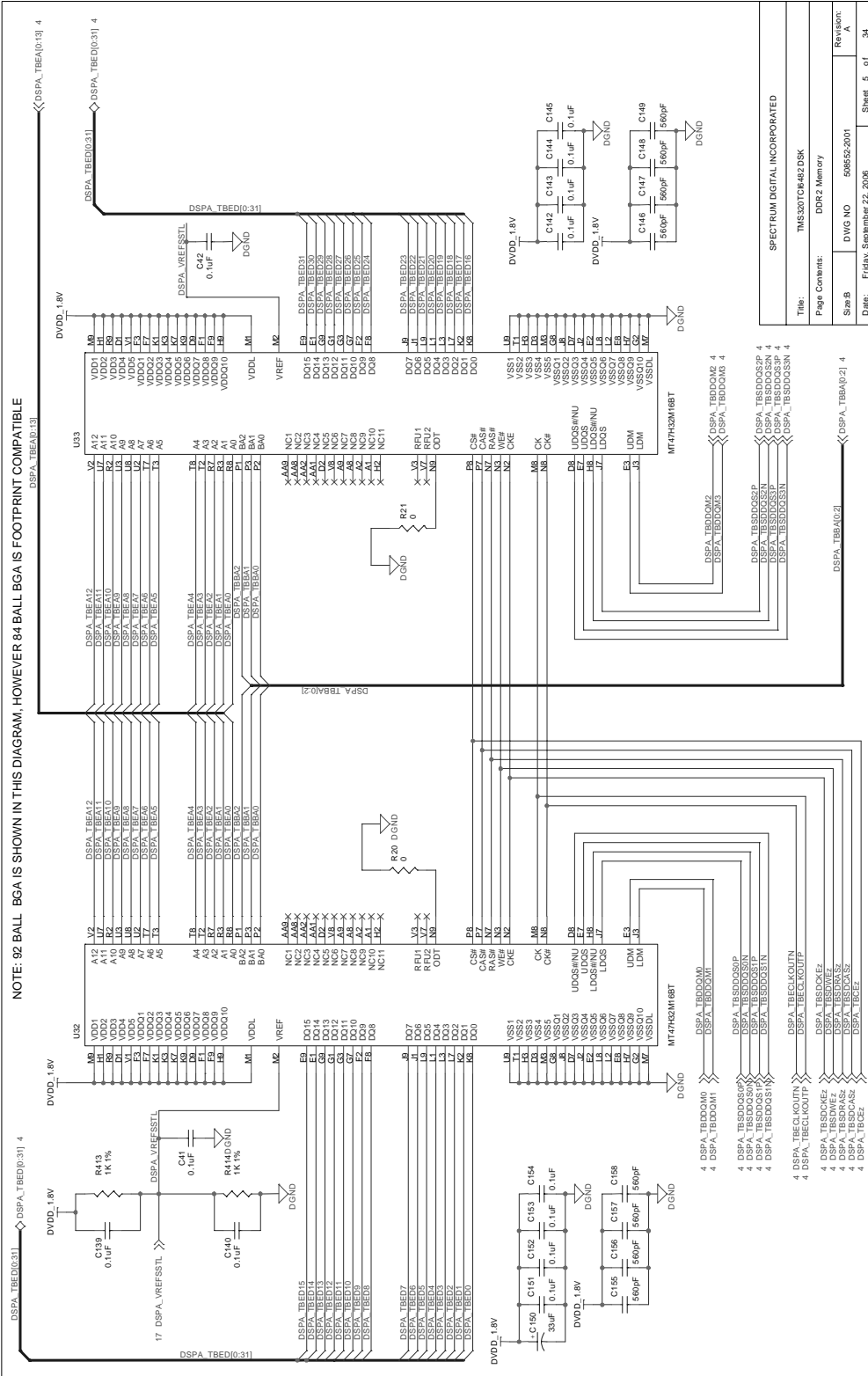

Time:	TMS320TC16482 DSK
Page Contents:	DDR2 Memory
Rev.B	DWG NO 508552001
Date:	Friday, September 22, 2006
Sheet	5 of 34

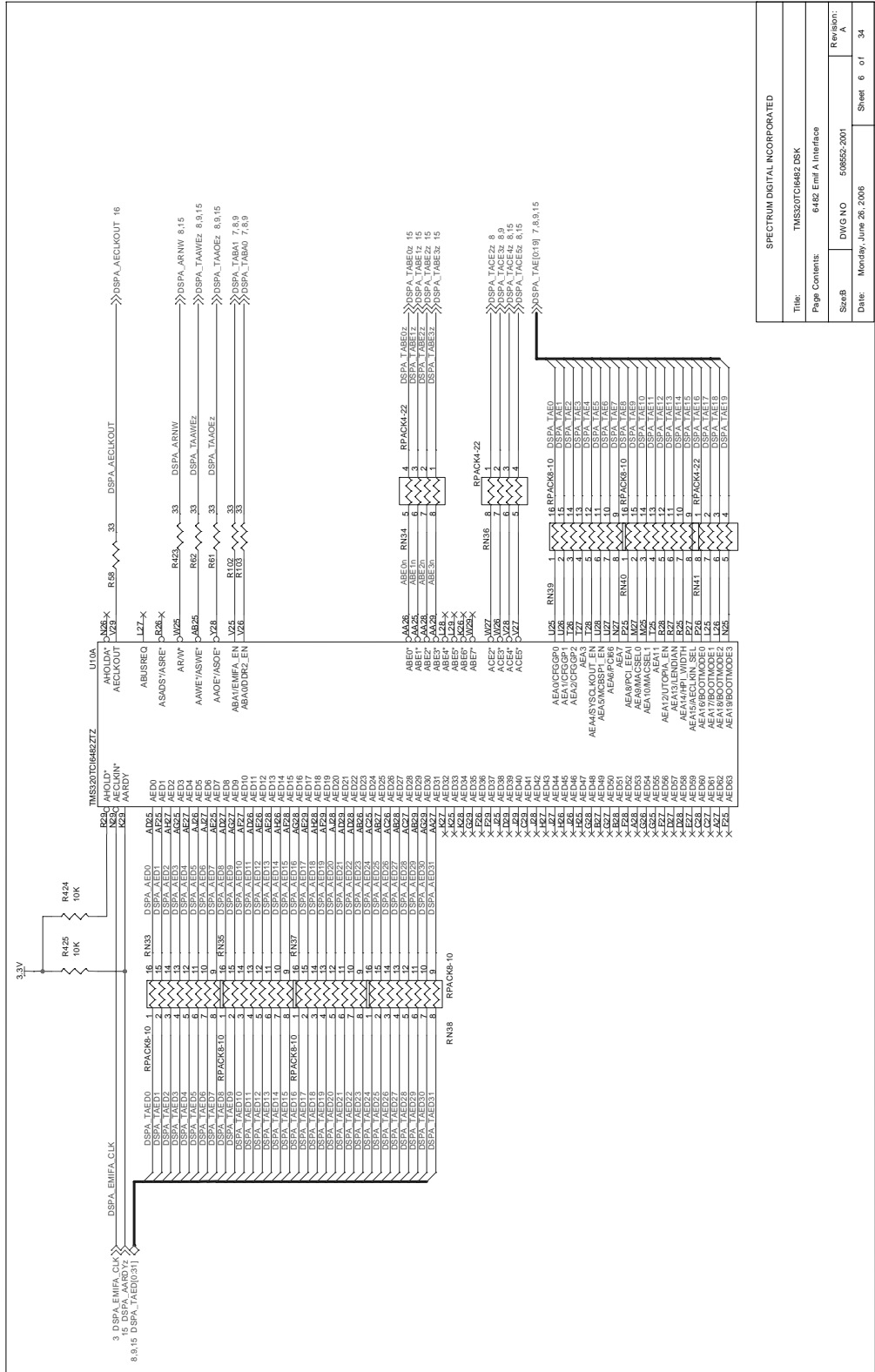

SPECTRUM DIGITAL INCORPORATED	
Title:	TMS320C6482 DSK
Page Contents:	6482 Emf A Interface
Sheet:	508552-2001
Date:	Monday, June 26, 2006
Revision:	A
Sheet:	6 of 34

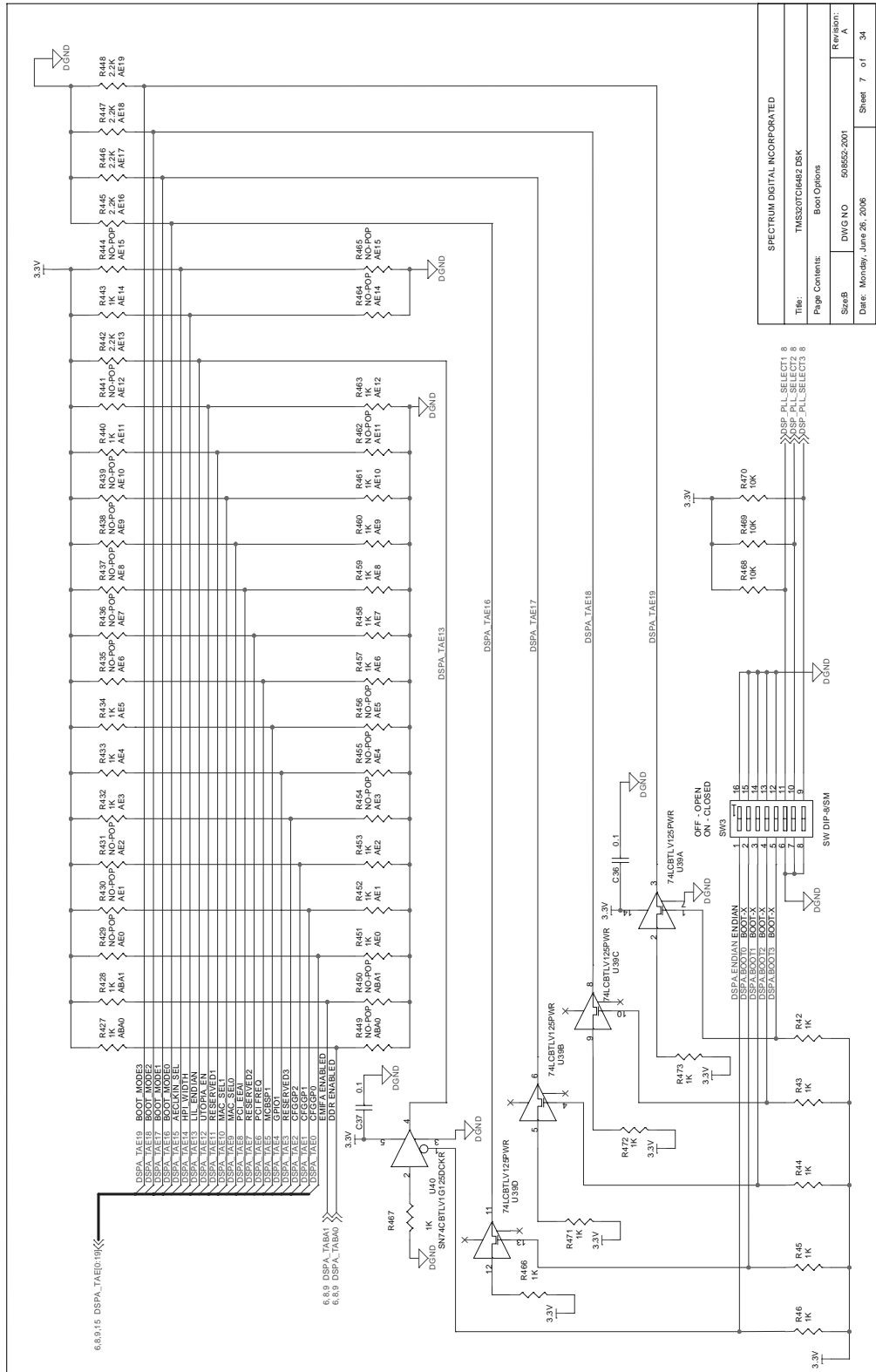

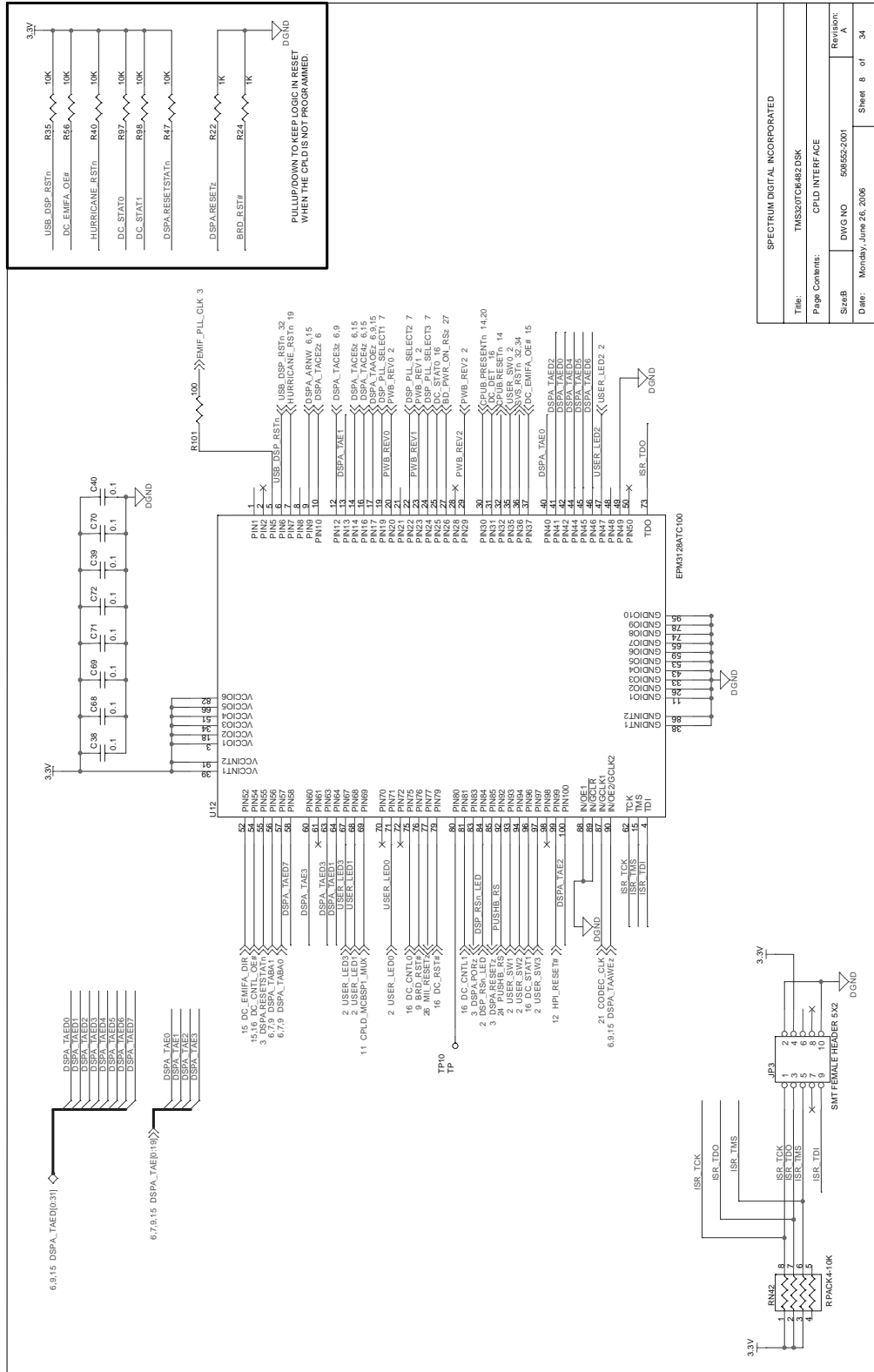

SPECTRUM DIGITAL INCORPORATED			
Time:	TMS200708482 DSK		
Page Contents:	CPLD INTERFACE		
Sheet:	DWGNO	598552-2001	Revision: A
Date:	Monday, June 26, 2006		Sheet 8 of 34

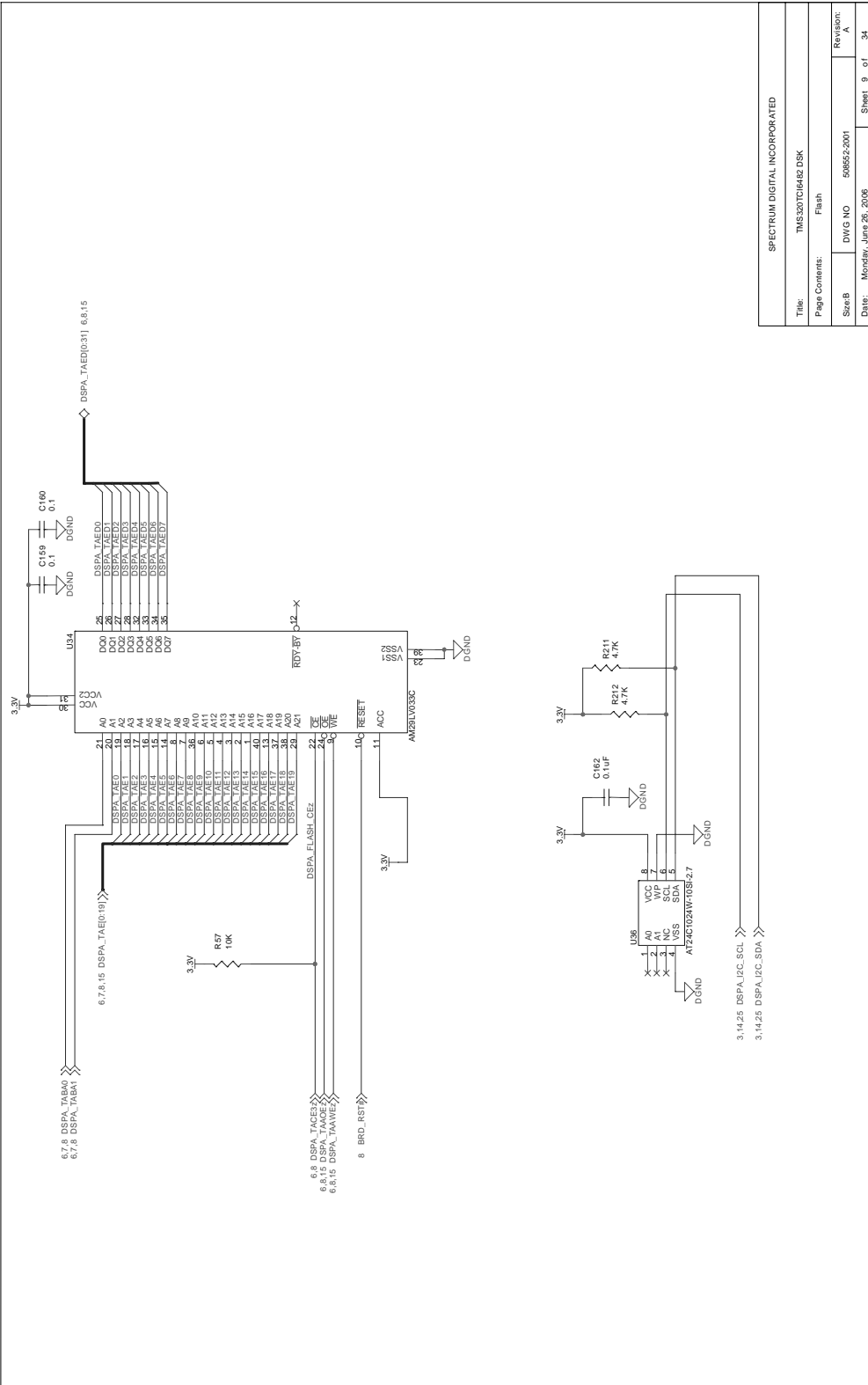

SPECTRUM DIGITAL INCORPORATED			
Title:	TMS320TC16482 DSK		
Page Contents:	Flash		
Size B:	DWG NO	596552-2001	Revision:
Date:	Monday, June 26, 2006		A
		Sheet 9	of 34

SPECTRUM DIGITAL INCORPORATED	
Title:	TMS320C64-42 DSK
Page Contents:	MII Interface
Size:	DWGNO 598552-2001
Date:	Monday, June 26, 2006
Revision:	A
Sheet 10 of 34	

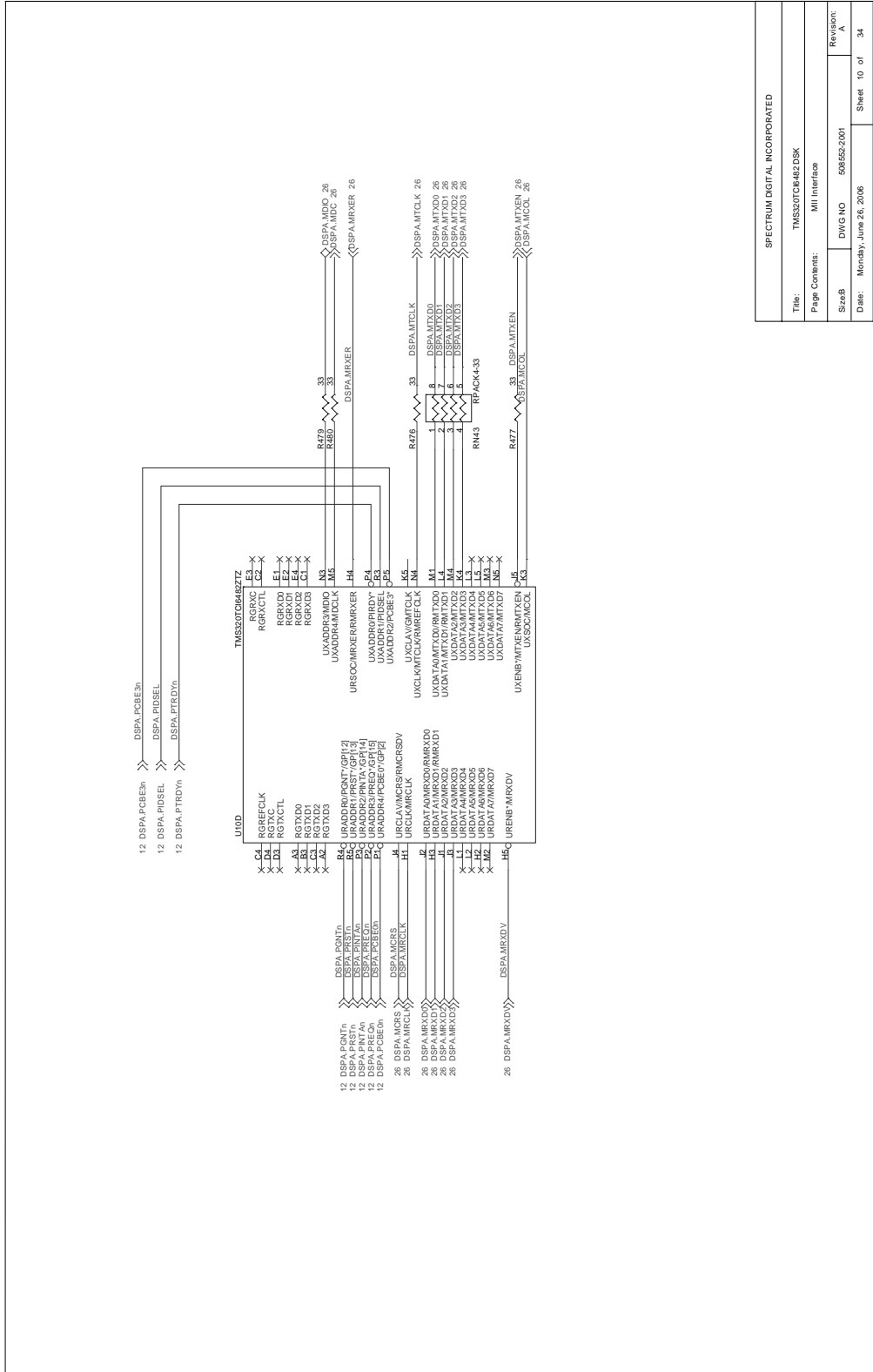

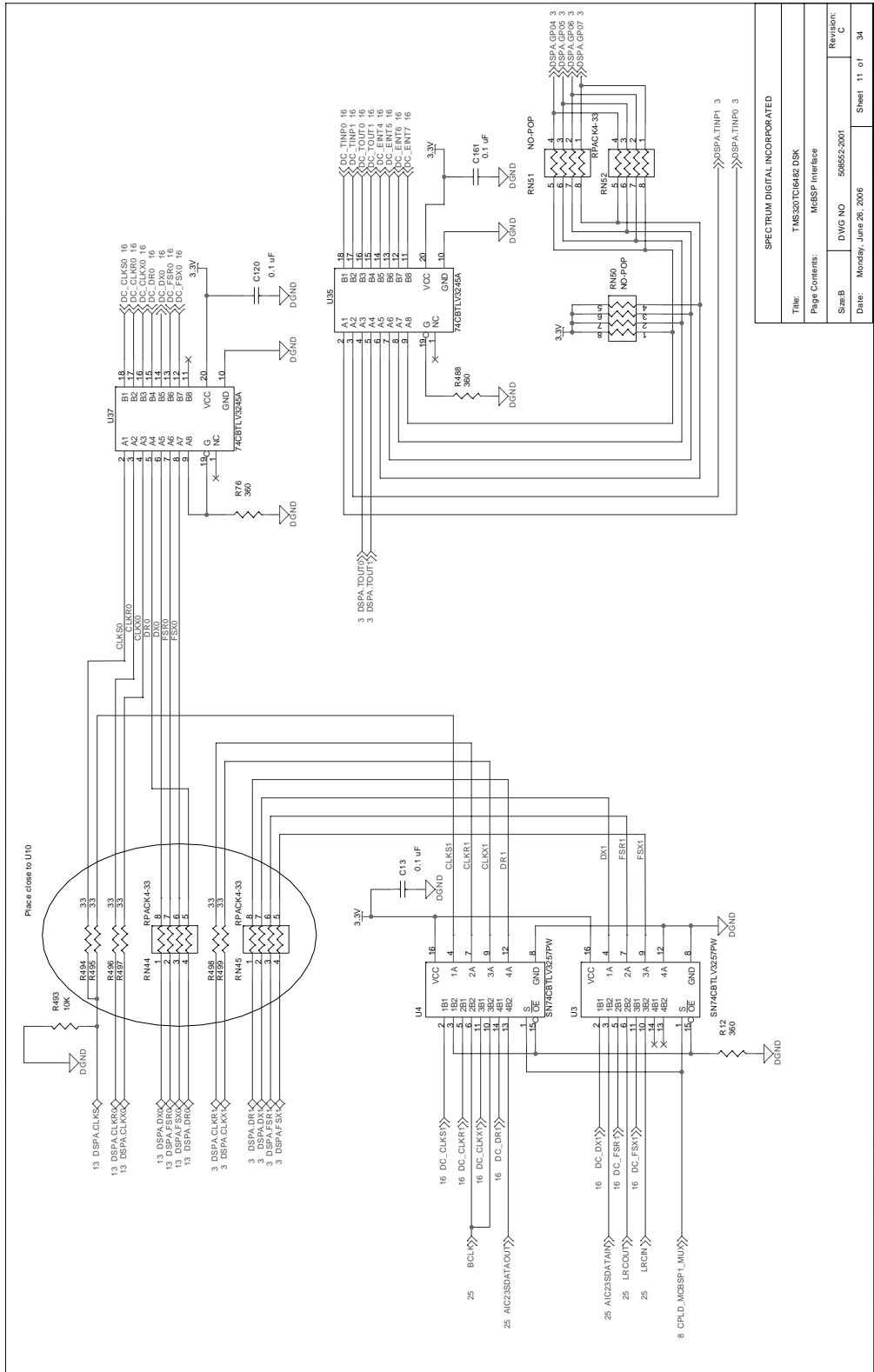

SPECTRUM DIGITAL INCORPORATED	
Title:	TMS320TC16482 DSK
Page Contents:	MSBSP Interface
Size:	DWG NO 50852.2001
Date:	Monday, June 28, 2006
Revision:	C
Sheet:	11 of 34

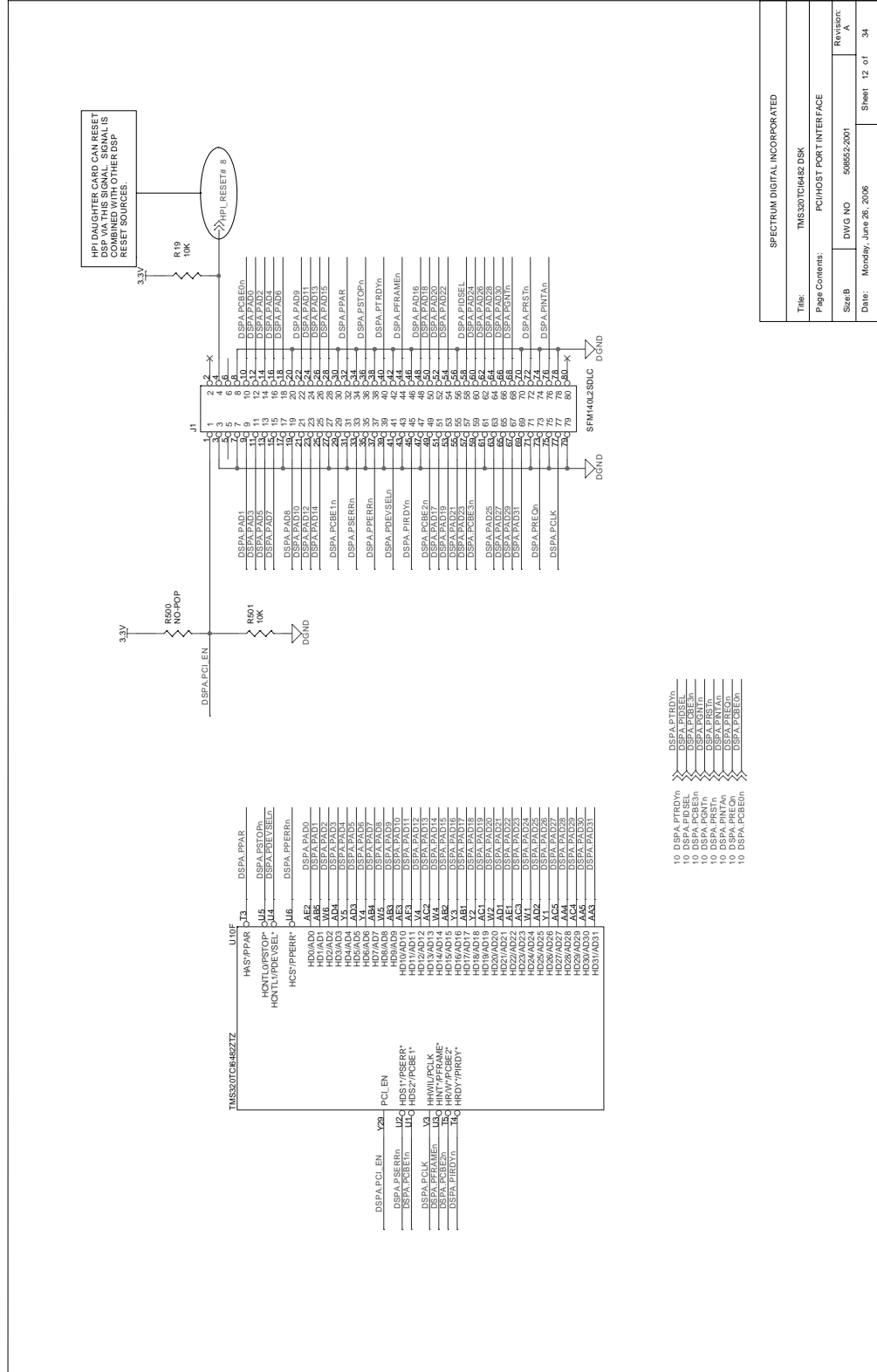

SPECTRUM DIGITAL INCORPORATED

Title:	TMS320C44H4Z DSK
Page Contents:	PCI/HOST PORT INTERFACE
Size:	B
DWG NO:	50852-2001
Date:	Monday, June 28, 2005
Revision:	A
Sheet	12 of 34

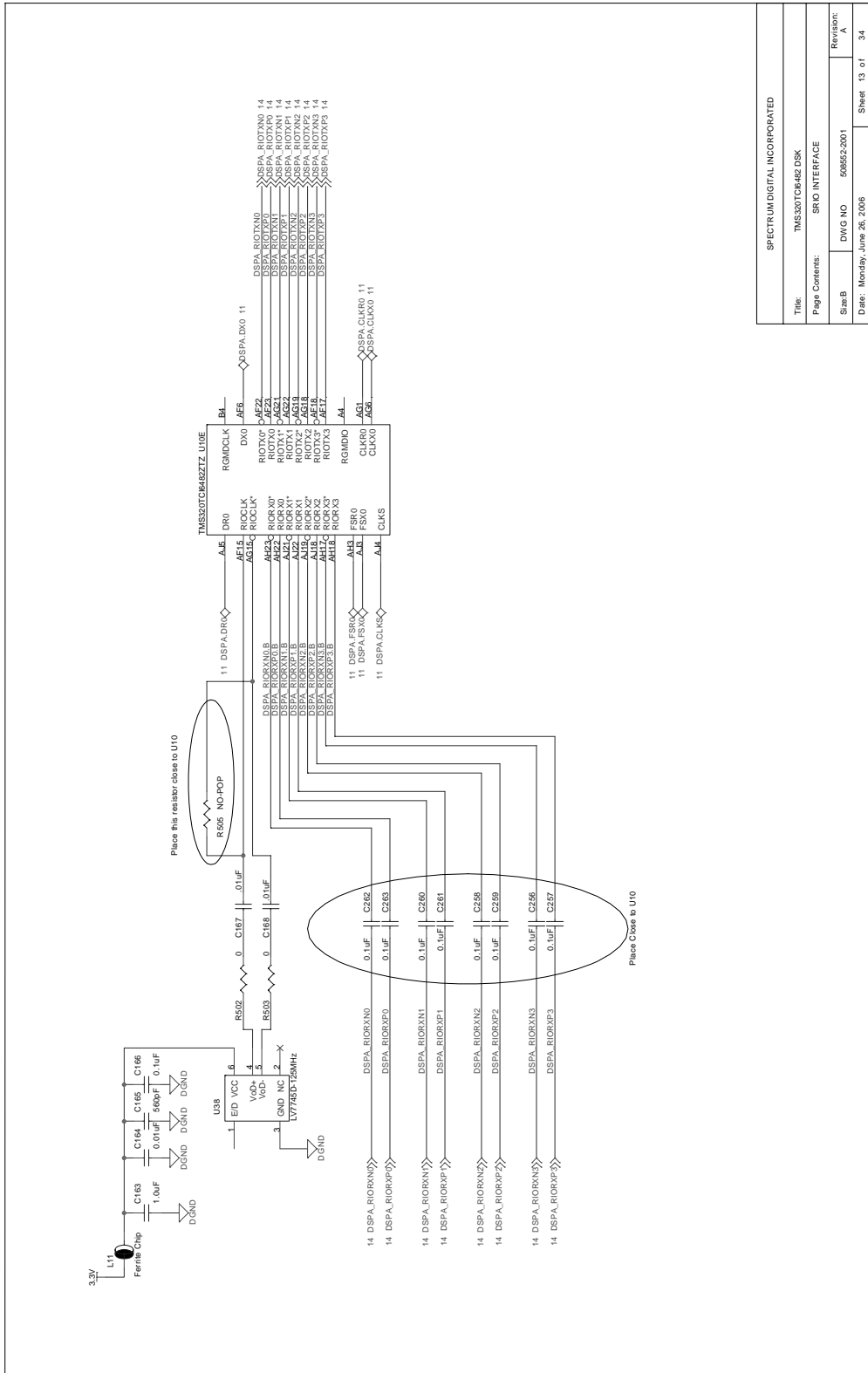

SPECTRUM DIGITAL INCORPORATED			
Title:	TMS320TC16482 DSK		
Page Contents:	SRIO INTERFACE		
Size:	DWG NO	50852-2001	Revision:
Date:	Monday, June 28, 2006		A
			Sheet 13 of 34

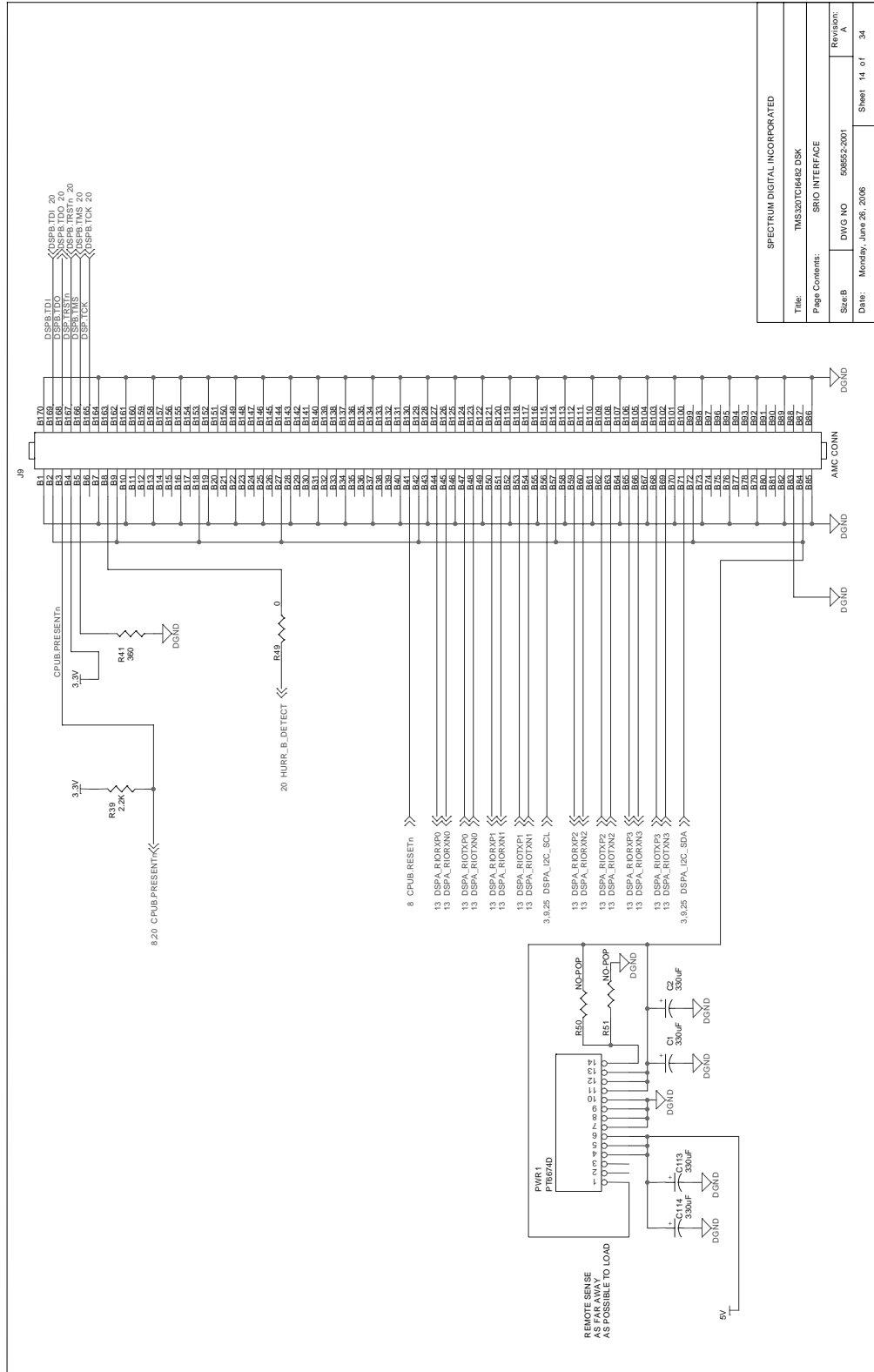

SPECTRUM DIGITAL INCORPORATED			
Title: TMS320C6482 DSK			
Page Contents: SRIO INTERFACE			
Size: B	DWG NO: 50852-2001	Revision: A	Sheet 14 of 34
Date: Monday, June 28, 2005			

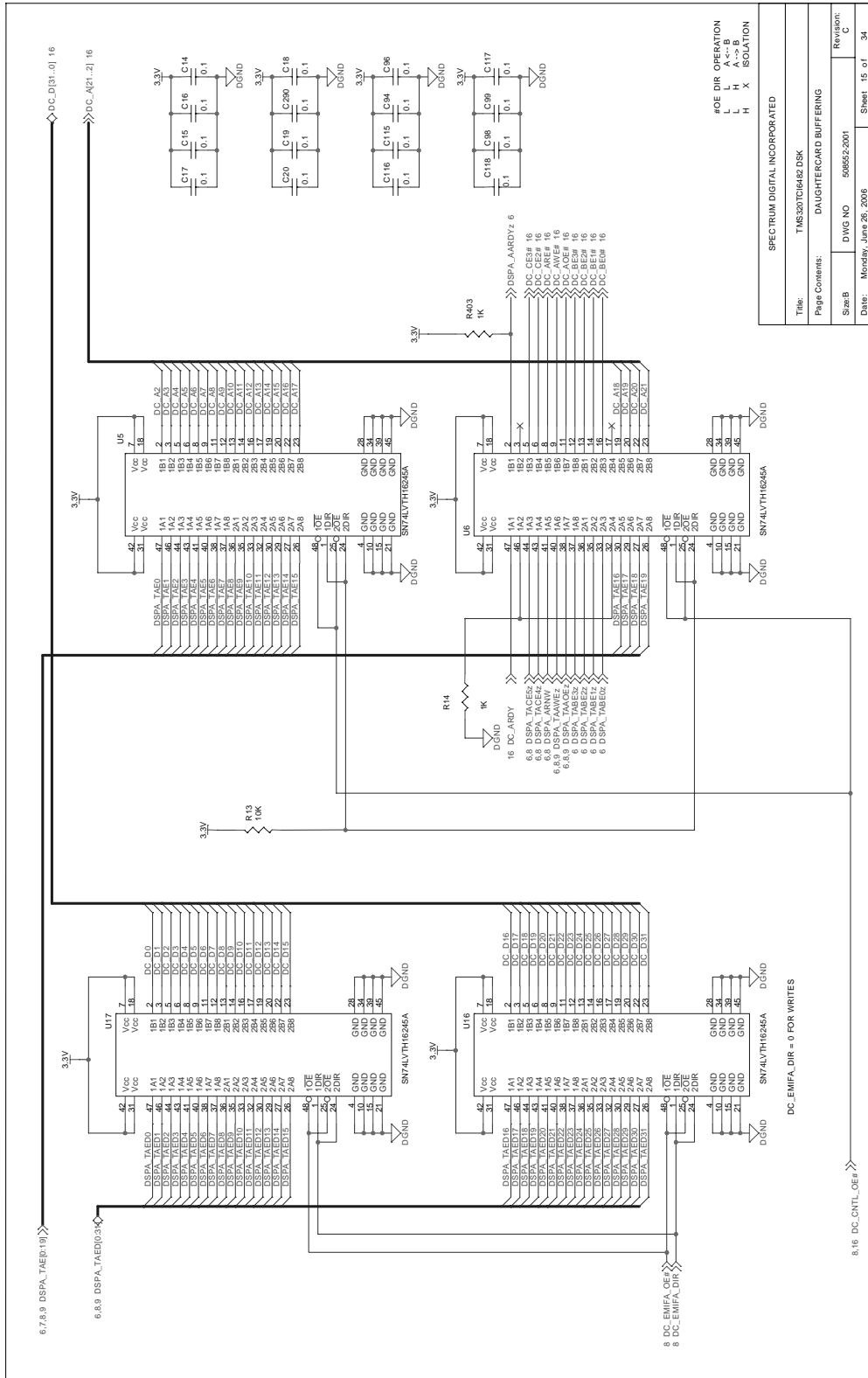

SPECTRUM DIGITAL INCORPORATED	
Title:	TMS320TC16482 DSK
Page Comments:	DAUGHTERCARD BUFFERING
Sheet:	DWG NO 598552-2001
Date:	Monday, June 26, 2006
Revision:	A B C
Sheet	15 of 34

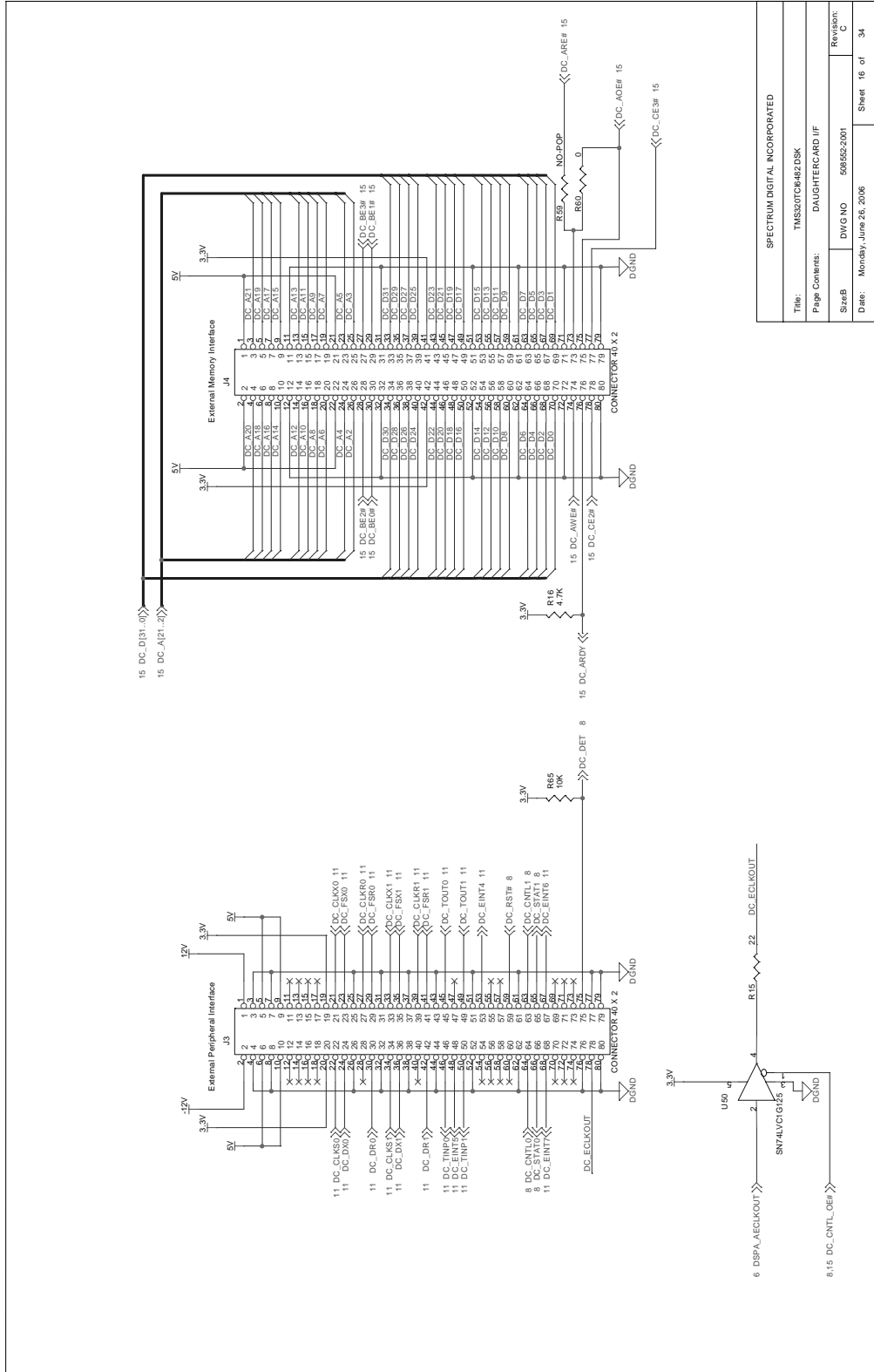

SPECTRUM DIGITAL INCORPORATED			
Title:	TMS320C482 DSK	Revision:	C
Page Contents:	DAUGHTERBOARD JIF	Sheet:	16 of 34
Sheet:	DWG/NO 598552-001	Date:	Monday, June 26, 2006

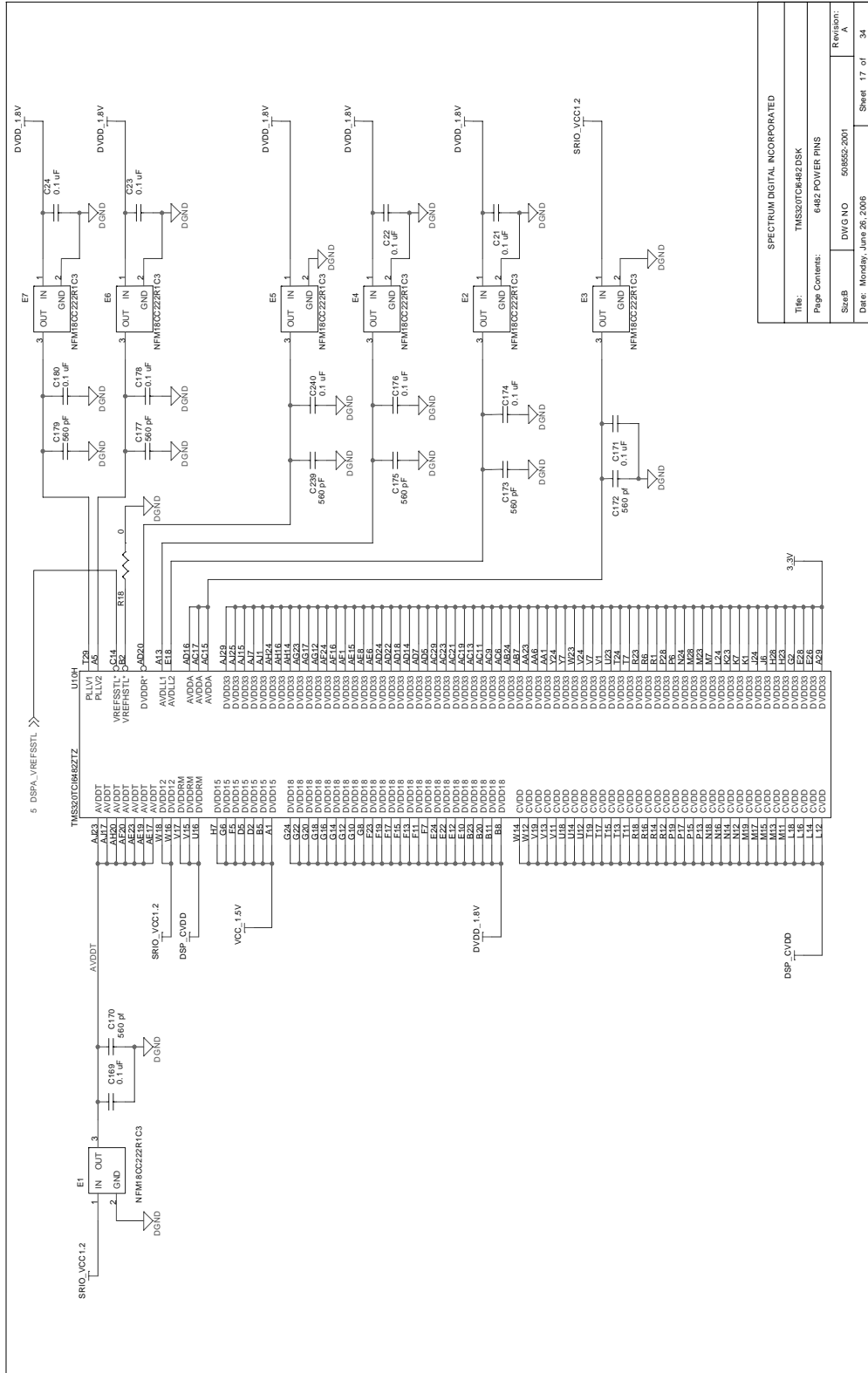

SPECTRUM DIGITAL INCORPORATED			
Title:	TMS320TC16482 DSK		
Page Contents:	6482 POWER PINS		
Size:	DWG NO	508552-2001	Revision:
Date:	Monday, June 26, 2006		
			Sheet 17 of 34

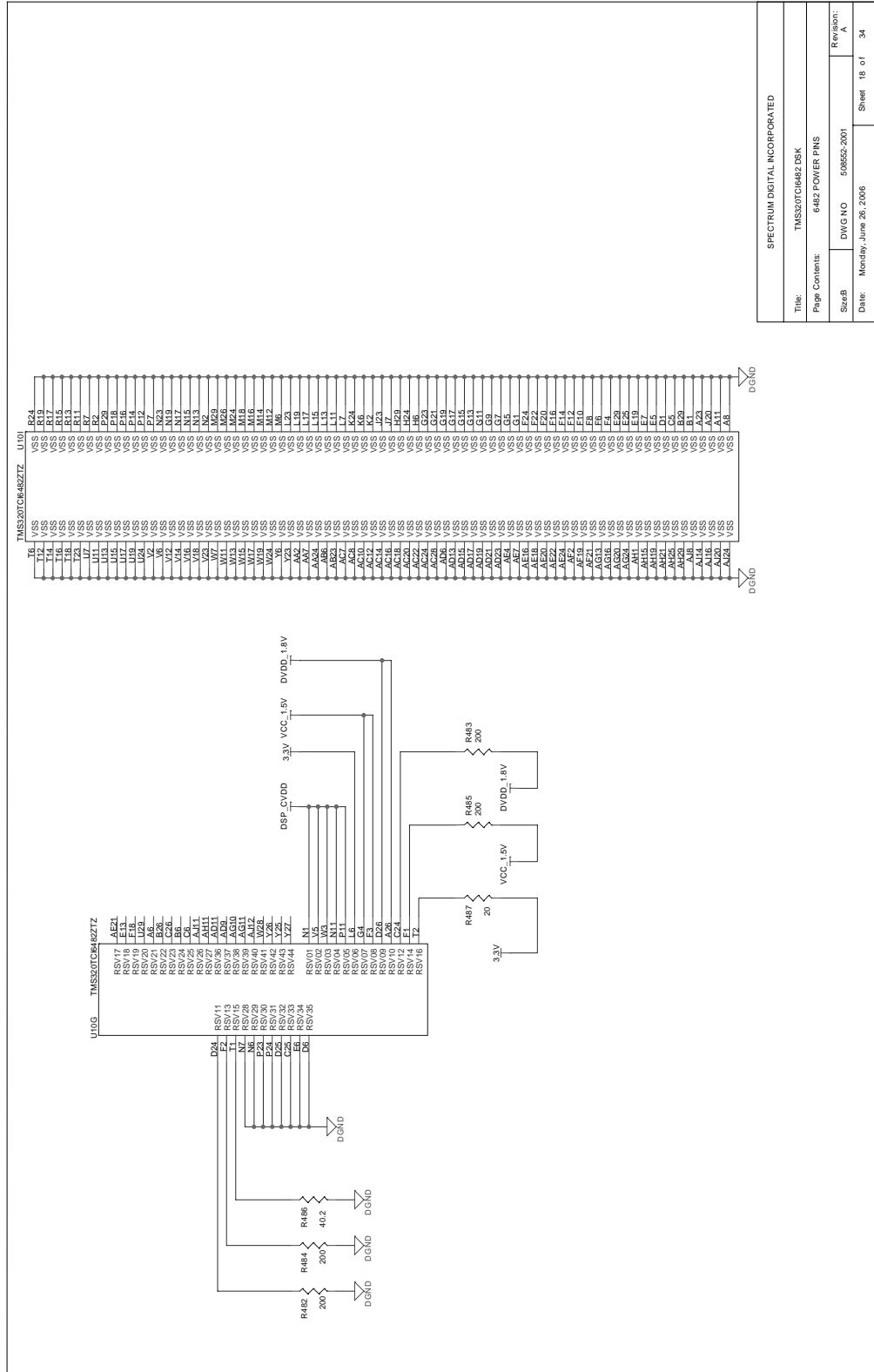

SPECTRUM DIGITAL INCORPORATED			
Title:	TMS320C6492ZSK		
Page Contents:	6482-POWER.PNS		
Sheet:	DWG NO	506552-2001	Revision: A
Date:	Monday, June 26, 2006	Sheet	18 of 34

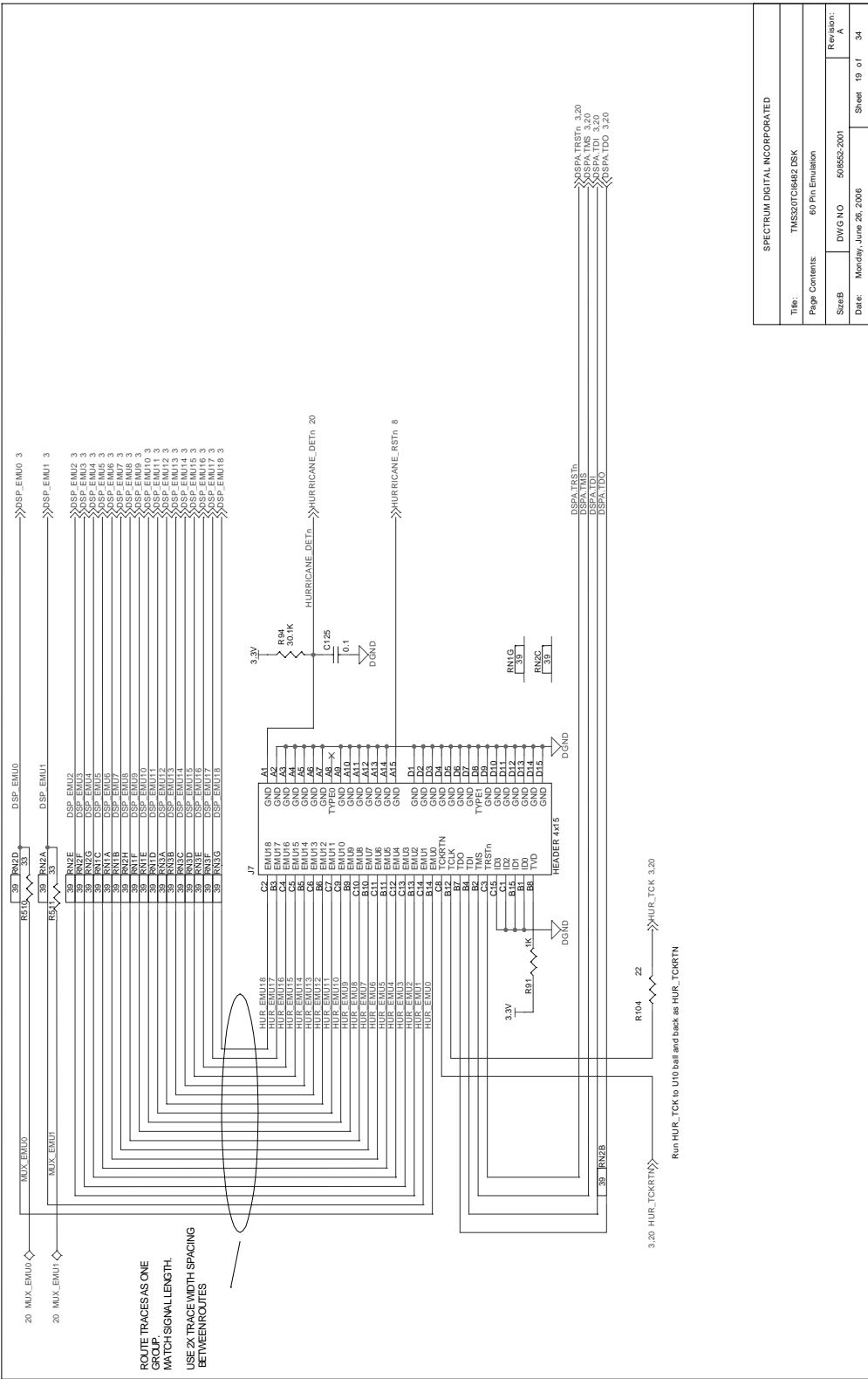

SPECTRUM DIGITAL INCORPORATED			
Title:	TMS320TC1642 DSK		
Page Content:	60 Pin Emulation		
Sheet:	DIVG-NO	508552-2001	Revision: A
Date:	Monday, June 26, 2006		Sheet 19 of 34

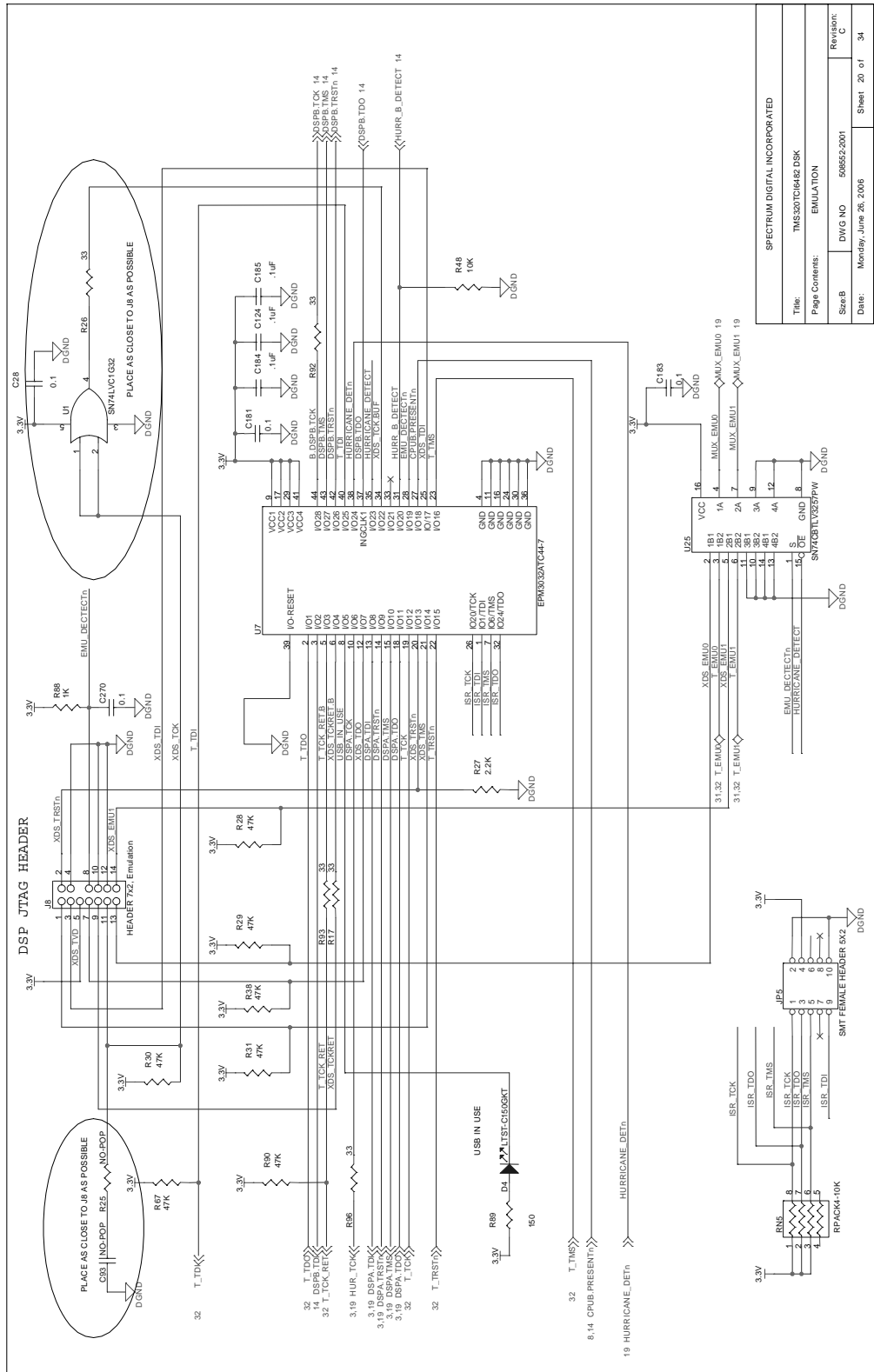

SPECTRUM DIGITAL INCORPORATED			
Title:	TMS320T0164Z DSK	Revision:	C
Page Contents:	EMULATION	Size:	B
Date:	Monday, June 26, 2006	DWG NO:	50852.2001
Sheet:	20 of 34		

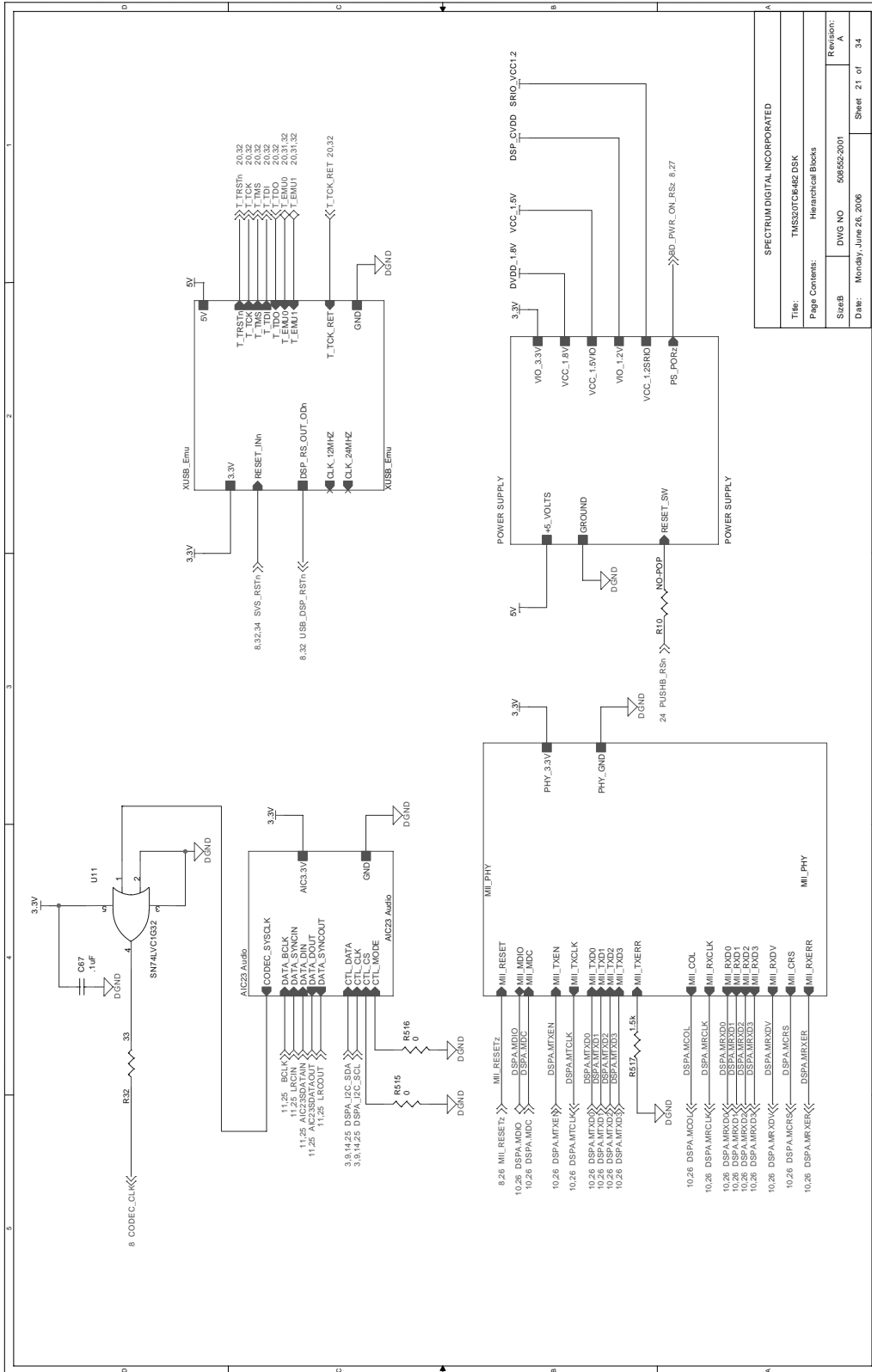

SPECTRUM DIGITAL INCORPORATED	
Title:	TMS320TC16482 DSK
Page Contents:	Hierarchical Blocks
SizeB	DWG NO 506552-2001
Date:	Monday, June 26, 2006
Revision:	A
Sheet	21 of 34

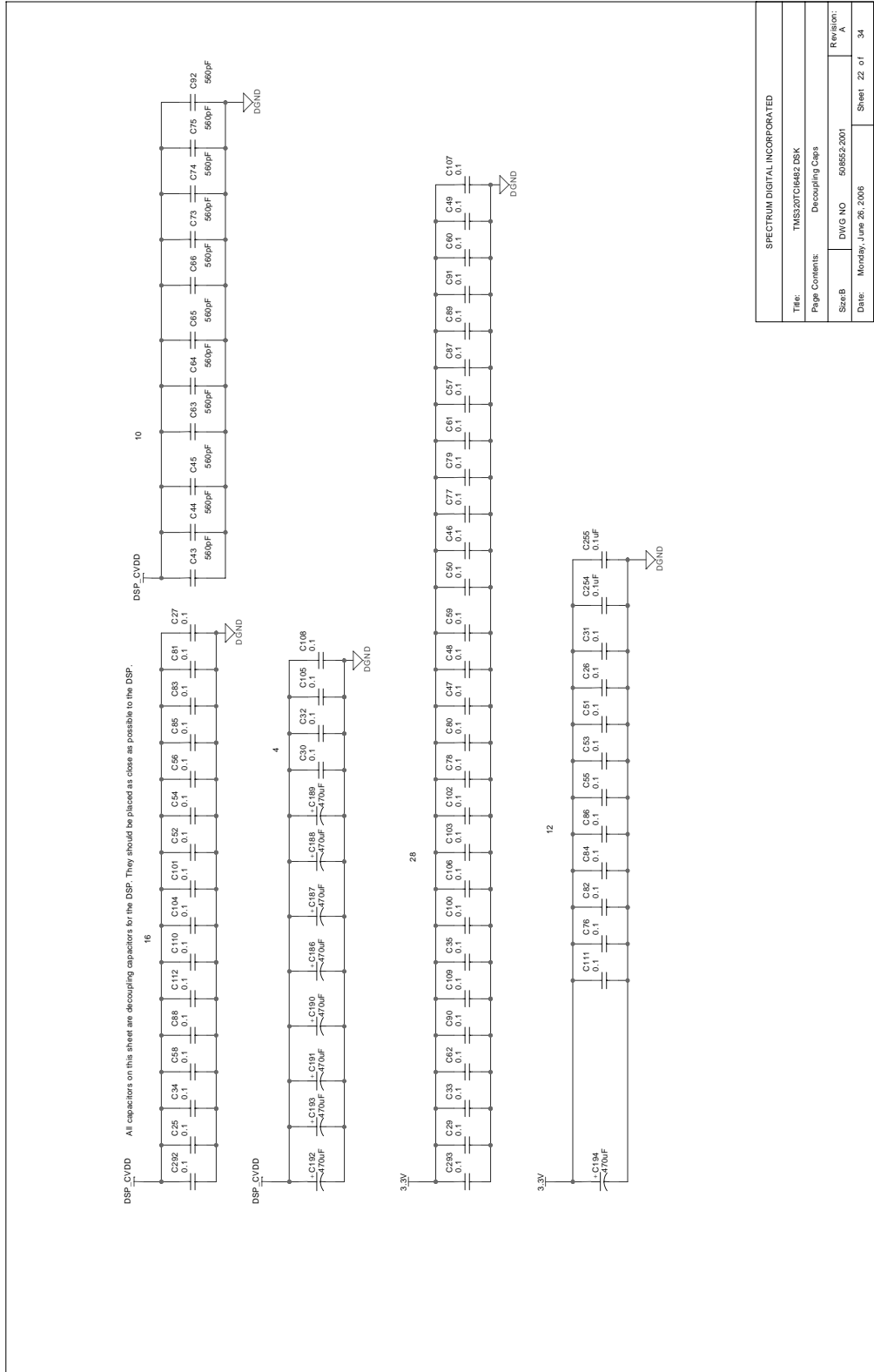

SPECTRUM DIGITAL INCORPORATED			
Title:	TMS3207C1642Z DSK		
Page Contents:	Decoupling Caps		
Size:	DWG NO	50852-2001	Revision:
Date:	Monday, June 26, 2006		A
			Sheet 22 of 34

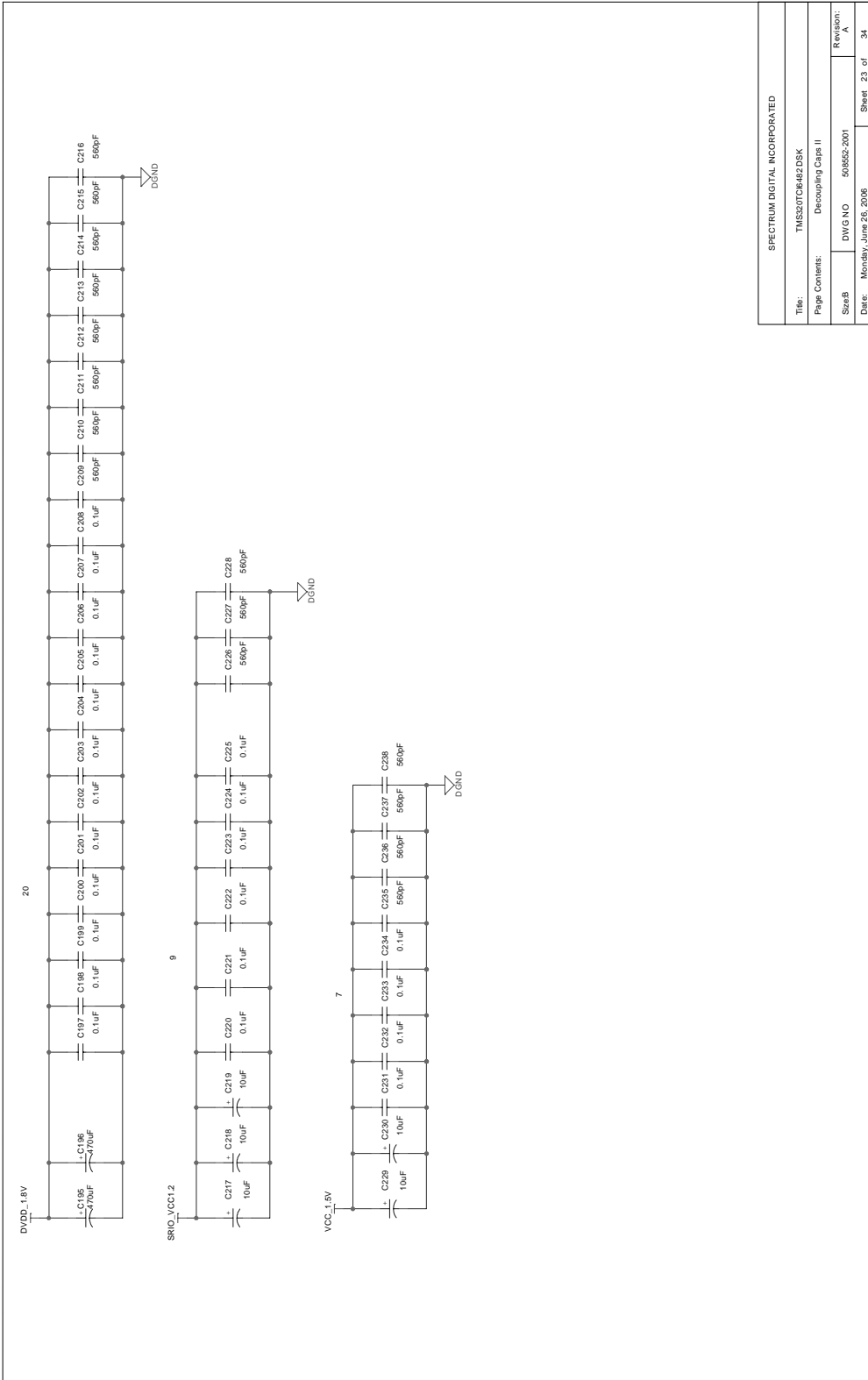

SPECTRUM DIGITAL INCORPORATED			
Title:	TMS320TC1642 DSK		
Page Content:	Decoupling Caps II		
Sheet:	DWG NO	50852-2001	Revision: A
Date:	Monday, June 26, 2006	Sheet 23 of	34

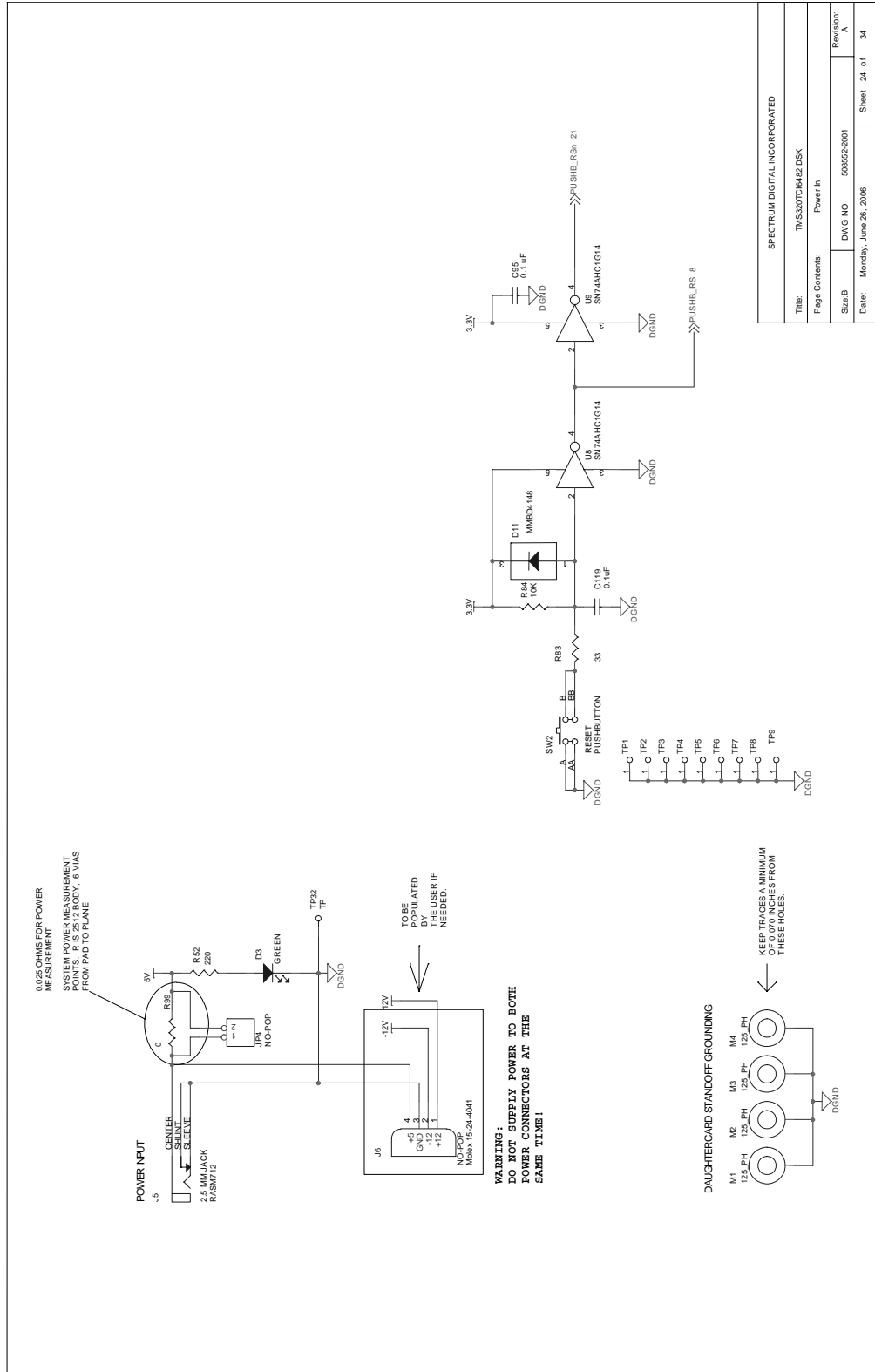

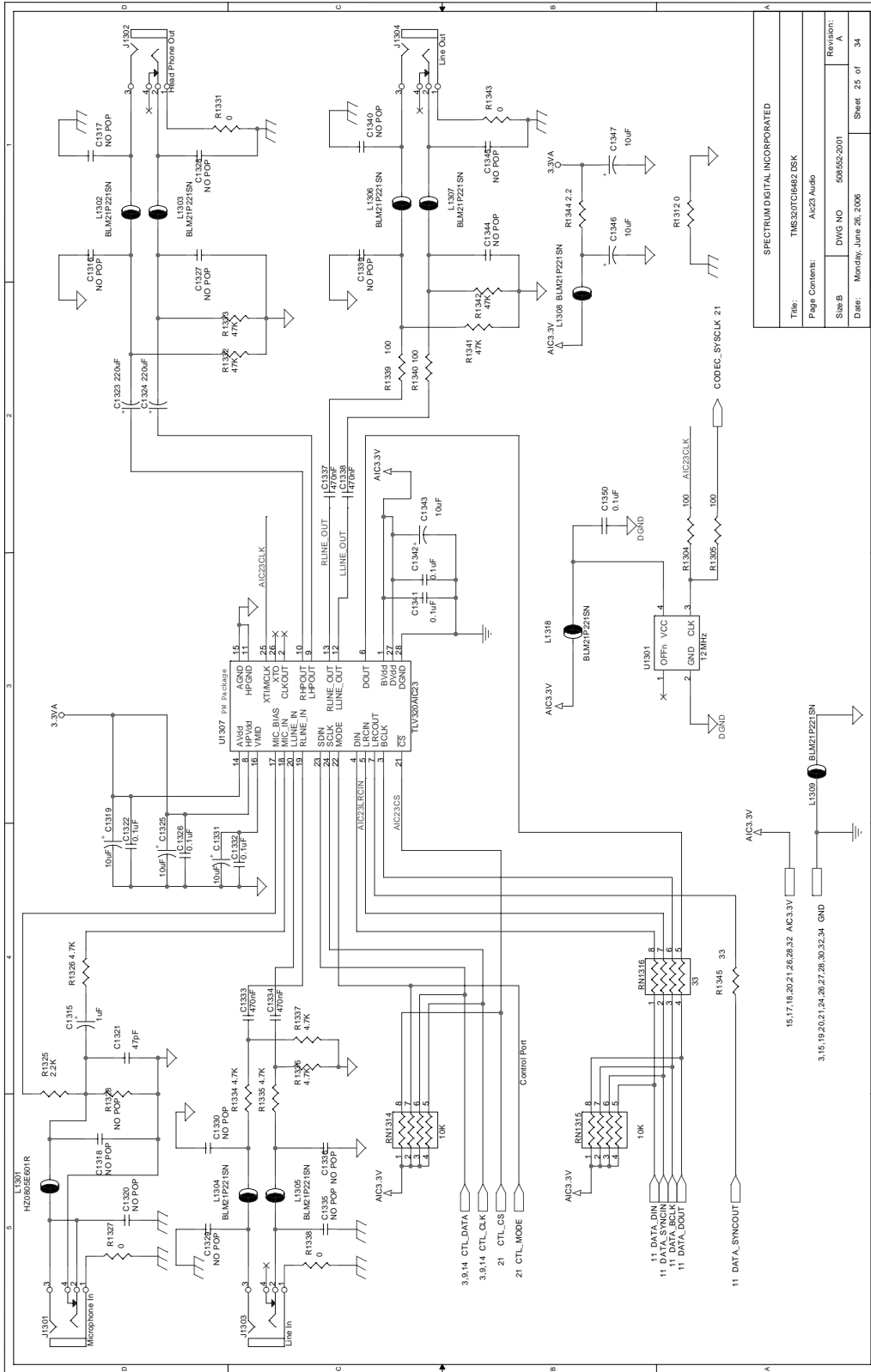

SPECTRUM DIGITAL INCORPORATED	
File:	TMS320TC16482 DSK
Page Contents:	AIC23 Audio
Size:B	DWG NO 598552-2001
Date:	Monday, June 26, 2006
Revision:	A
Sheet 25 of	34

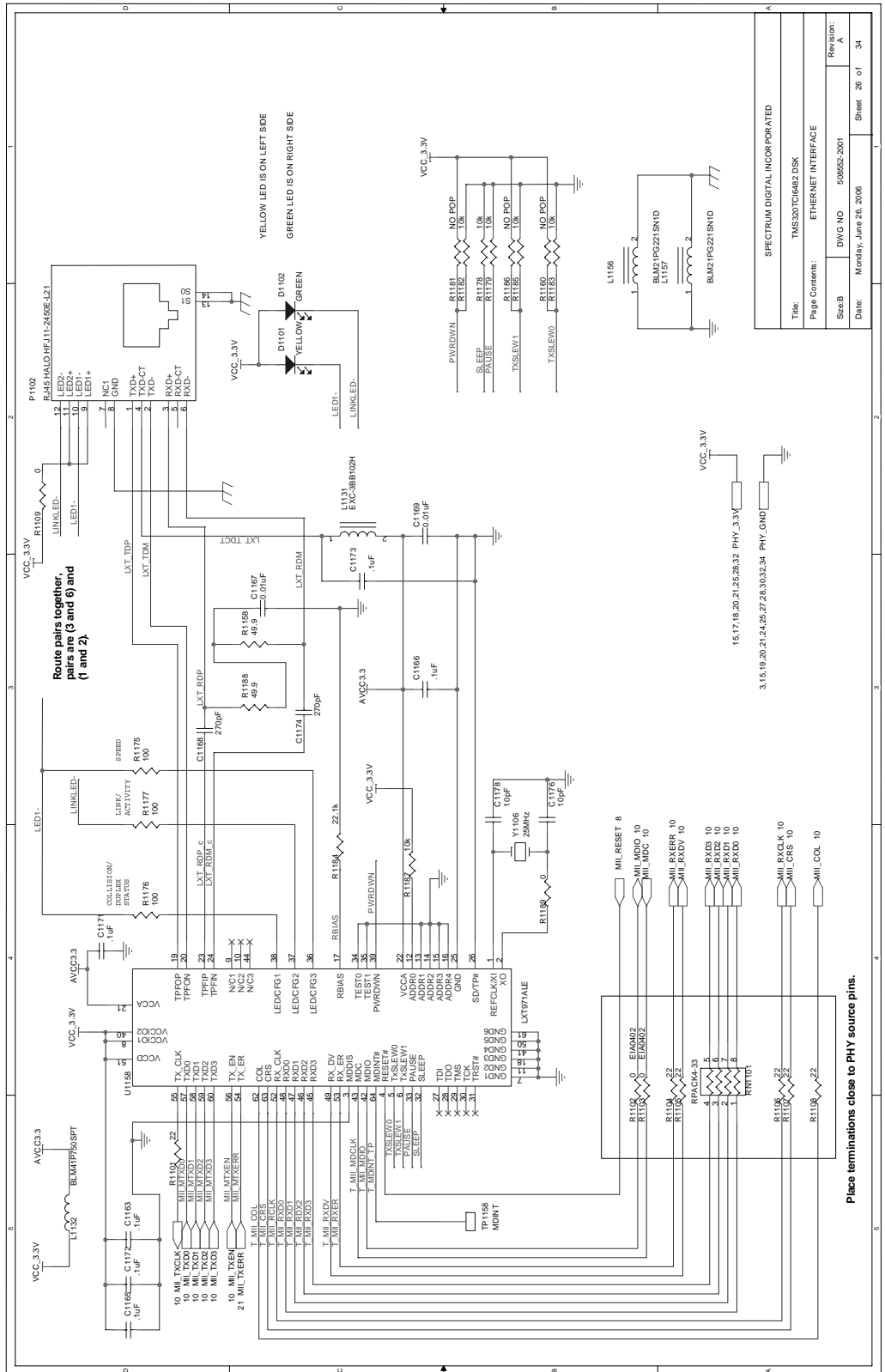

SPECTRUM DIGITAL INCORPORATED	
Part No:	TMS320C16482 DSK
Page Contents:	ETHERNET INTERFACE
Size B:	DWG NO 50852-2001
Date:	Monday, June 26, 2006
Revision:	A
Sheet	26 of 34

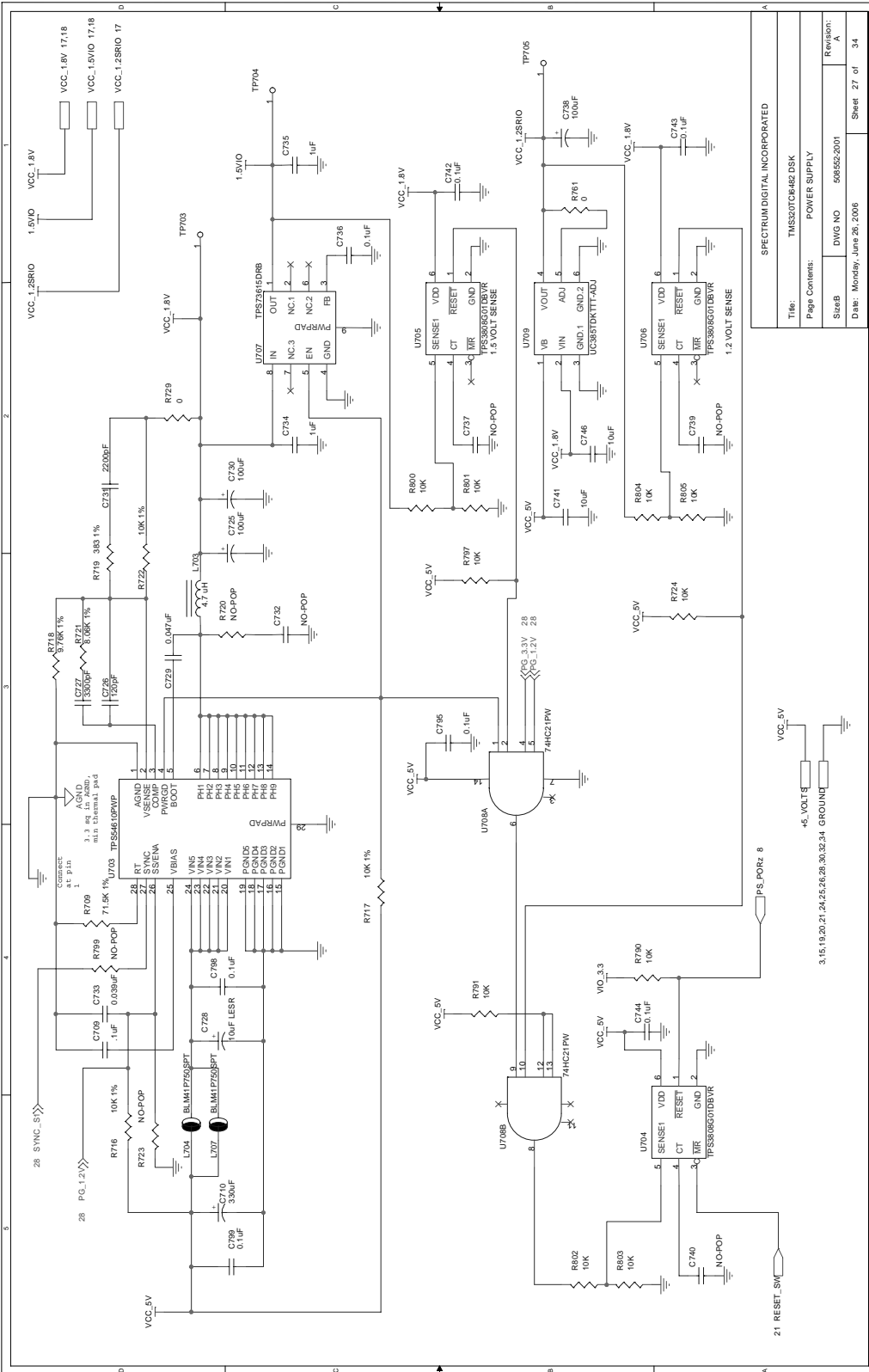

SPECTRUM DIGITAL INCORPORATED	
Title:	TMS320TC16482 DSK
Page Contents:	POWER SUPPLY
Size:	Size B
DWG NO:	598552-2001
Date:	Monday, June 26, 2006
Revision:	A
Sheet:	27 of 34

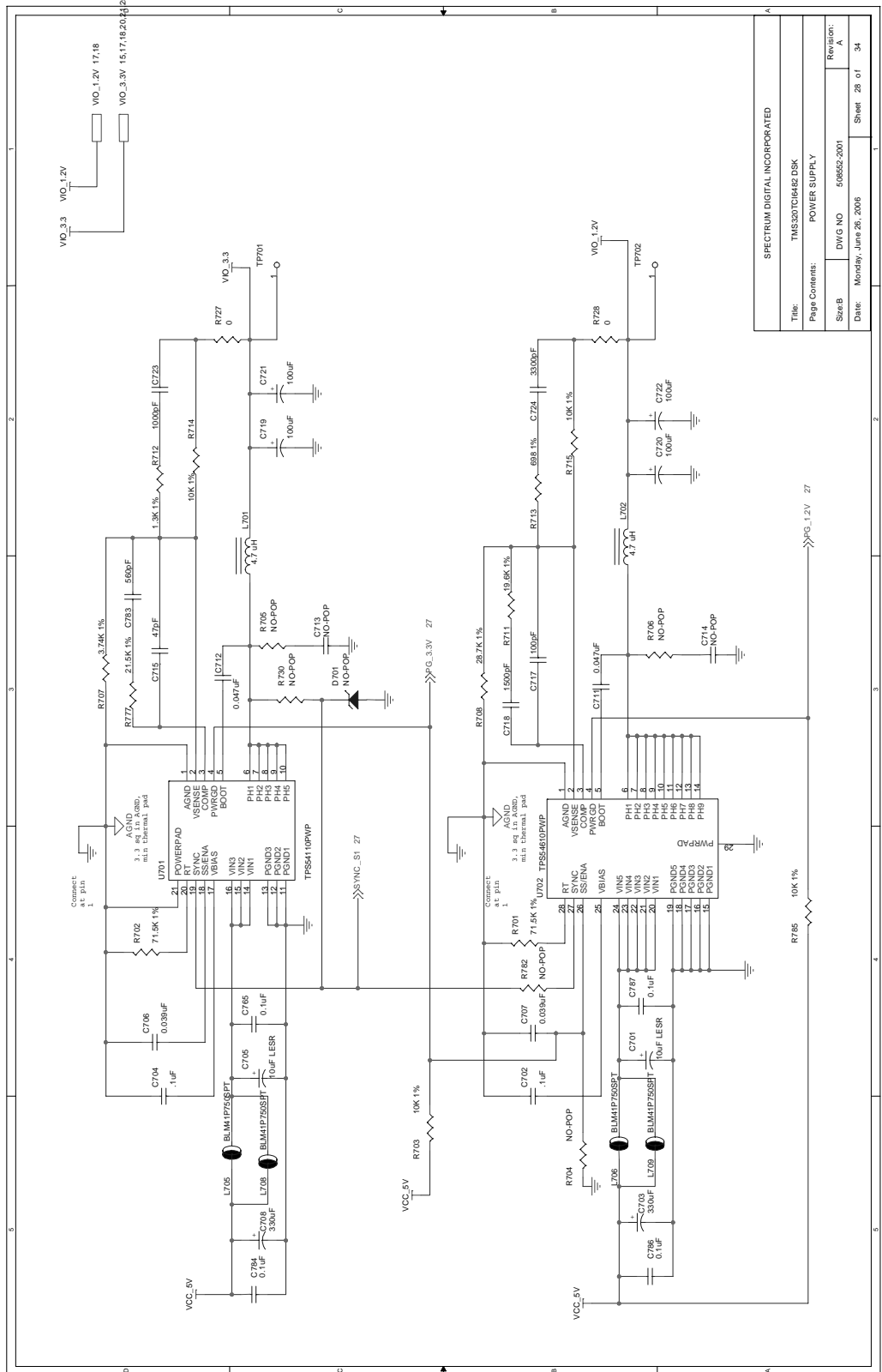

SPECTRUM DIGITAL, INCORPORATED	
Title:	TMS320C6412 DSK
Page Contents:	POWER SUPPLY
Size B:	DWG NO 50852-2001
Date:	Monday, June 26, 2006
Revision:	A
Sheet	28 of 34

Appendix B

Mechanical Information

This appendix contains the mechanical information about the TMS320C6482 DSK produced by Spectrum Digital.

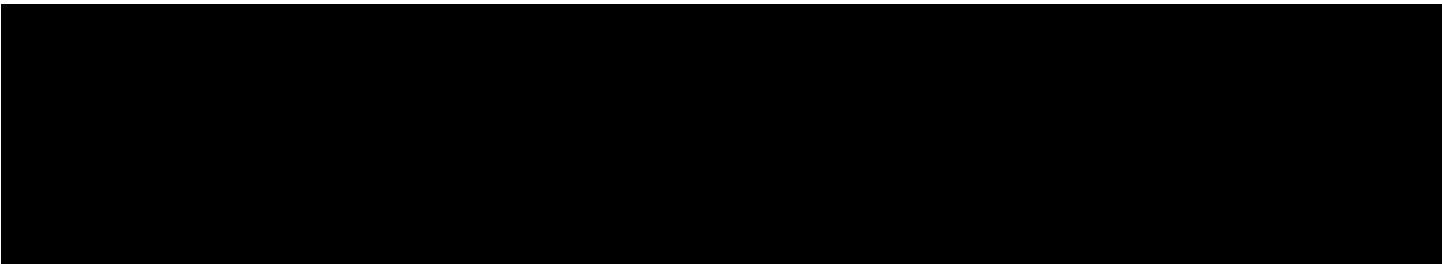

Printed in U.S.A., September 2006
508555-0201 Rev. C